

EuroCombi



A/23 MFFI - A/27 MFFI

G.C.N. 47-116-10 / 47-116-12

Servicing Instructions

Type C Boilers

**LEAVE THESE INSTRUCTIONS
ADJACENT TO THE GAS METER**

1. SERVICING INSTRUCTIONS

1.1 Replacement of Parts	3
1.2 To Gain General Access	
- Removing the Front Panel	3
- Removing the Side Panels	4
- To Lower the Control Panel	4
1.3 Access to the Combustion Chamber	
- Removing the Sealed Combustion Chamber	5
- Removing the Burner and Injectors	5
- Removing the Electrodes	6
- Removing the Main Heat Exchanger	7
- Removing the Air Pressure Switch	7
- Removing the Venturi Device	8
- Removing the Fan	8
1.4 Servicing and Removal of the Gas Valve	
- Setting Gas Pressure	9
- Removing the Spark Ignitor	11
- Removing the Gas Valve	12
1.5 Access to the Hydraulic Circuit	
- Removing the D.H.W. (Secondary) Exchanger	12
- Removing the Safety Valve	13
- Removing the Automatic Air Vent	13
- Removing the Main Flow Circuit Switch	13
- Removing the Pump	14
- Removing the Pressure Gauge	14
- Removing the Expansion Vessel	15
- Removing the Overheat Thermostat	15
- Removing the Heating Temperature Sensor (N.T.C.)	15
1.6 Access to the Control System	
- Checking the Fuses	16
- Removing the Time Clock	16
- Removing the P.C.B.s	17

2. FAULT FINDING

2.1 Fault Finding Guide (Flow-chart)	18
2.2 Fault Finding Using the Total Check System	23

3. ELECTRICAL DIAGRAMS

3.1 Electrical Connection	24
3.2 Functional Flow Connection	25

4. SHORT SPARE PARTS LIST	26
----------------------------------	-----------

1. **SERVICING INSTRUCTIONS**

To ensure efficient safe operation, it is recommended that the boiler is serviced annually by a competent person.

Before starting any servicing work, ensure both the gas and electrical supplies to the boiler are isolated and the boiler is cool.

Before and after servicing, a combustion analysis should be made via the flue sampling point (please refer to the Installation Manual for further details).

After servicing, preliminary electrical system checks must be carried out to ensure electrical safety (i.e. polarity, earth continuity, resistance to earth and short circuit).

1.1 **Replacement of Parts**

The life of individual components vary and they will need servicing or replacing as and when faults develop.

The fault finding sequence chart in chapter 2 will help to locate which component is the cause of any malfunction, and instructions for removal, inspection and replacement of the individual parts are given in the following pages.

1.2 **To Gain General Access**

All testing and maintenance operations on the boiler require the control panel to be lowered. This will also require the removal of the casing.

To dismantle the front part of the casing, proceed as follows:

1. Remove screw "A" (see fig. 1.1);
2. Lift the front panel up and forward (see fig. 1.2).

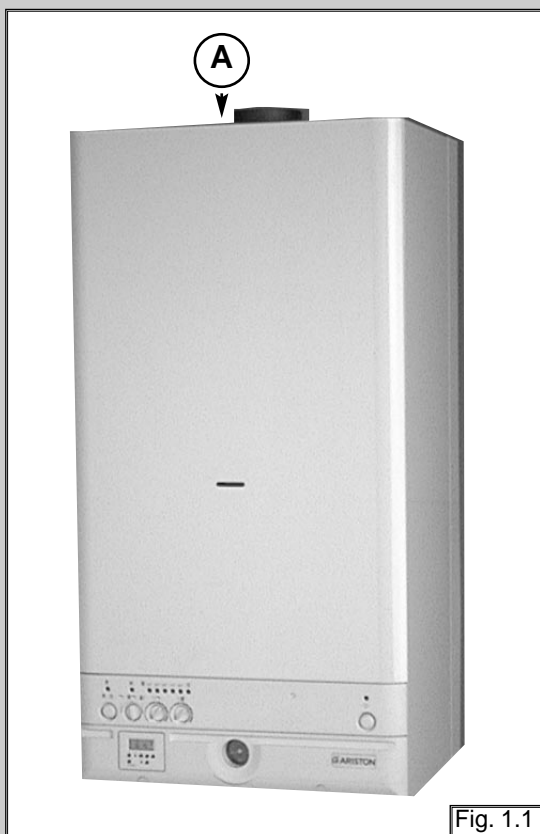



Fig. 1.3

Removing the side panels

1. Remove the screws "B";
2. Pull the panel away from the boiler, then lift the panel up and away from the boiler (see fig. 1.2).

To lower control panel

1. Remove the screws "B"
2. Push the two side panels outward slightly (fig. 1.5);
3. Rotate the control panel forward and down.

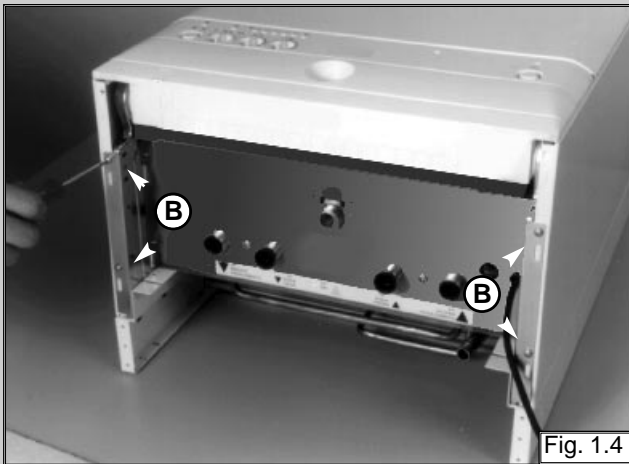

Fig. 1.4

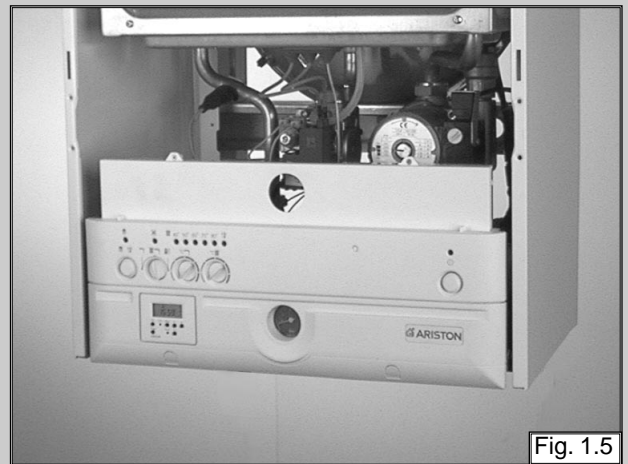

Fig. 1.5

To access the areas where the adjustment and control devices are located, simply remove the plugs by pressing from the inside, unscrew the screws "C" and remove the bottom part of the instrument panel, rotating it upwards.



Fig. 1.6

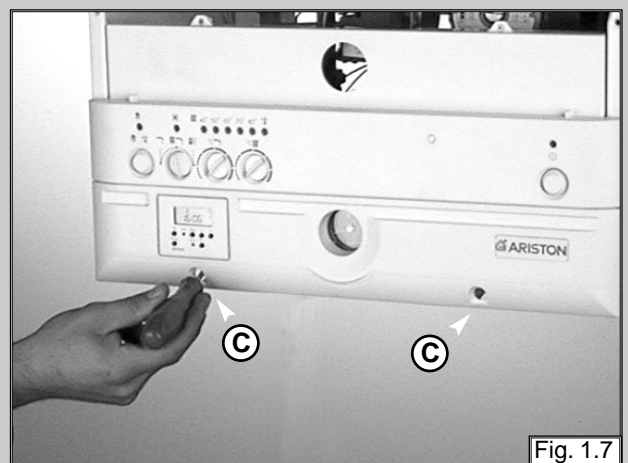
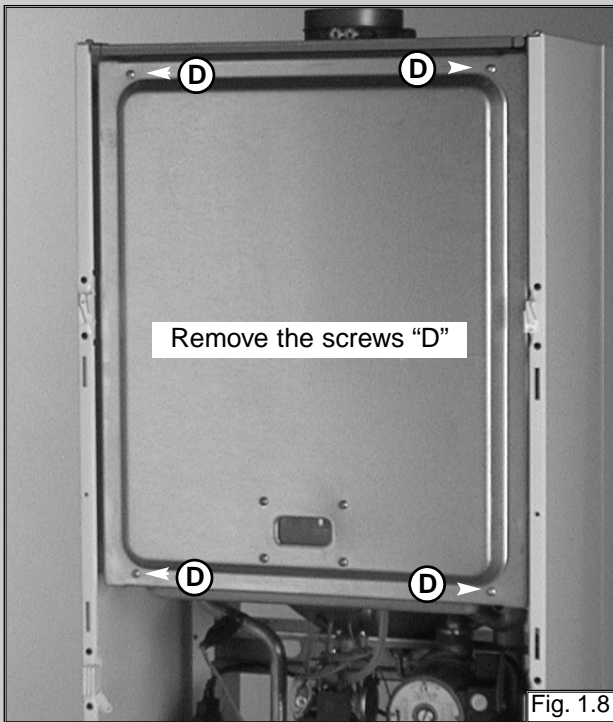

Fig. 1.7

1.3 Access to the Combustion Chamber

Removing the sealed chamber frontal cover



Removing the combustion cover

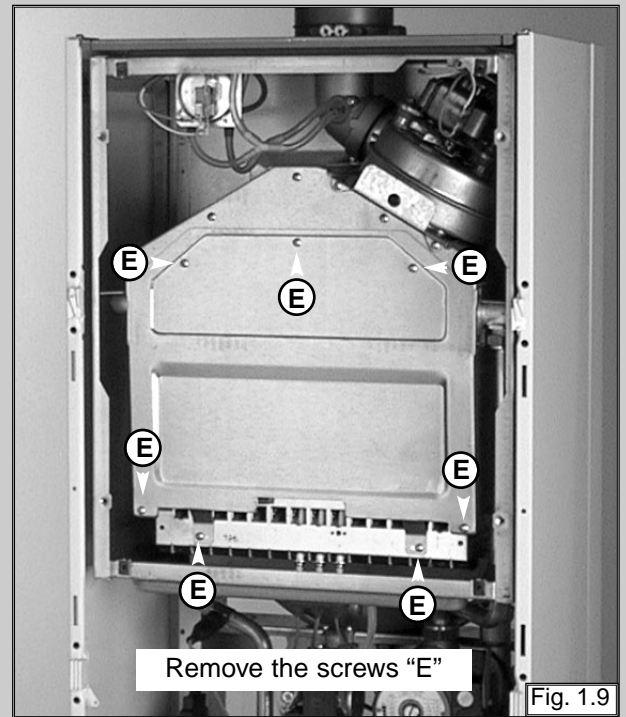

Removing the burner and the injectors

1. Remove the side panels of sealed chamber (fig. 1.10);
2. Remove the screws "F" of the burner (see fig. 1.11);
3. Remove the burner (see fig. 1.12);
4. Remove the injectors using a No. 7 socket spanner;
5. Replace in reverse order.

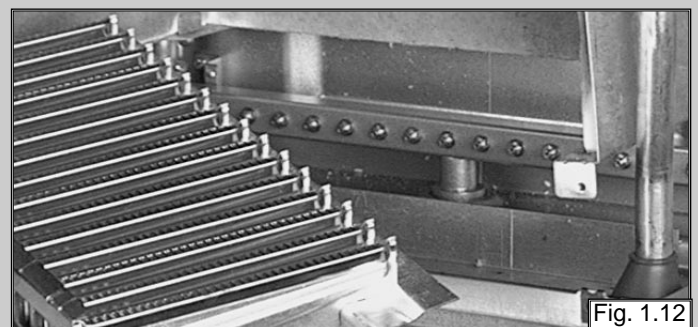
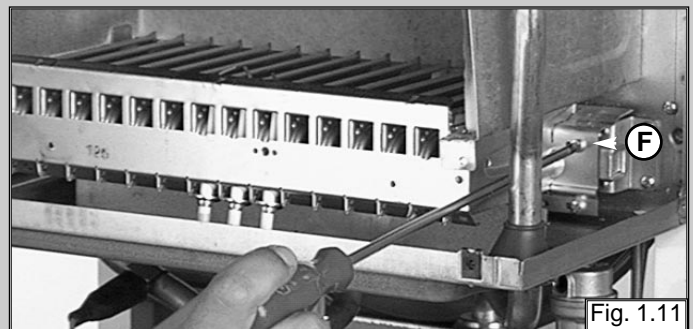
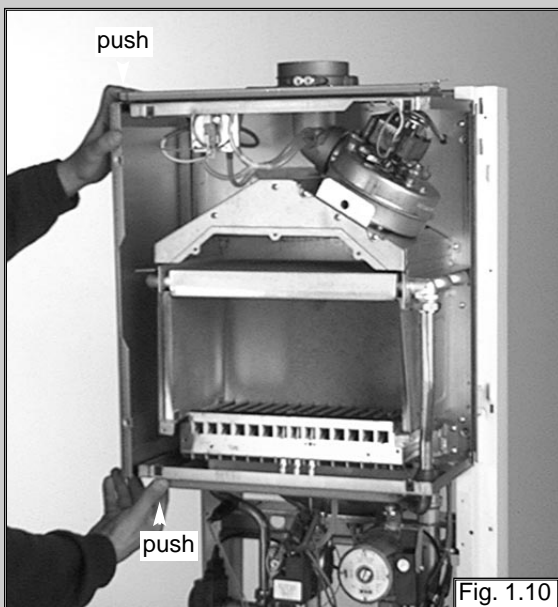

Removing the electrodes

1. Remove rubber gasket "G" (see fig. 1.13);
2. Disconnect ignition leads by pulling downward (see fig. 1.14);
3. To remove the flame sensor, disconnect the cable at its only connection point close to the P.C.B. (see fig. 1.15);

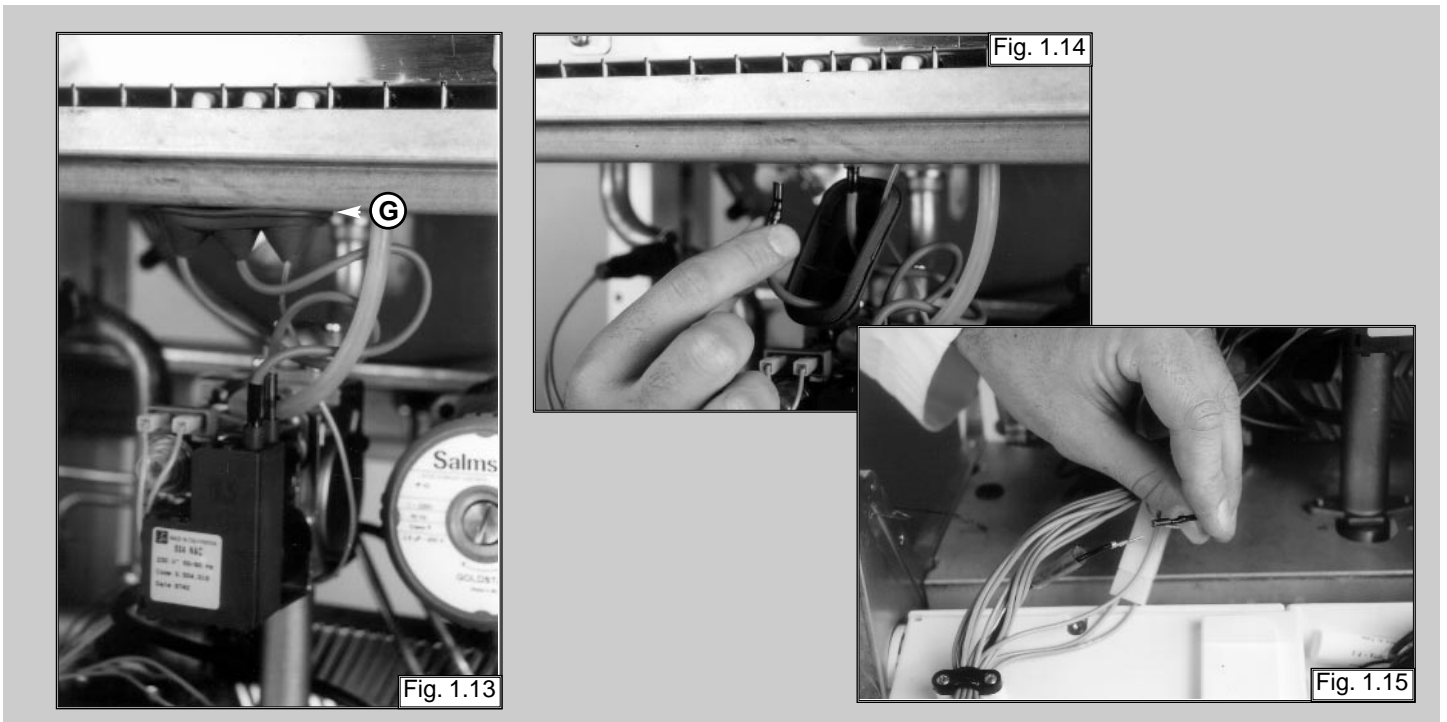

5. Remove screw "H" using a Philips No. 2 star tip screwdriver (see fig. 1.16);
6. Slide the electrode gently downward (see fig. 1.17).

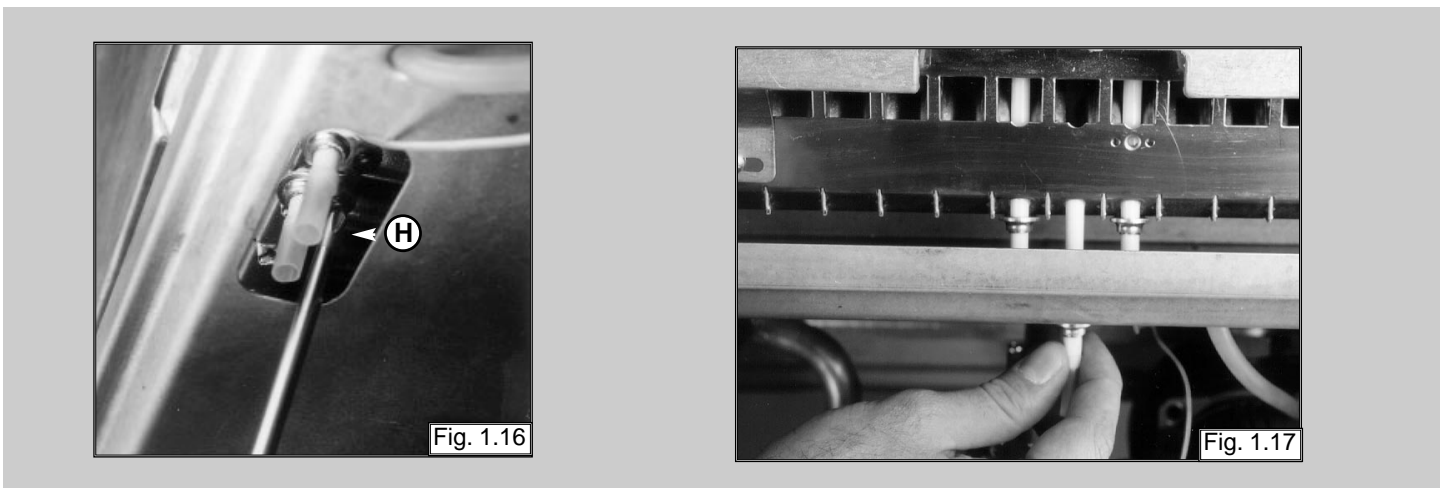

To replace, repeat the steps in reverse order, paying particular attention to the following:

- a - Centre the electrode in the positioning hole carefully, otherwise the electrode may break;
- b - Check that the cables have been connected correctly;
- c - Check that the rubber gasket covers the cable/electrode connection point completely.

Removing the main heat exchanger

1. Drain the boiler of water;
2. Release the two connection nuts "I" connecting the exchanger to the flow and return pipes (see fig. 1.18);
3. Pull it straight out (see fig. 1.19).

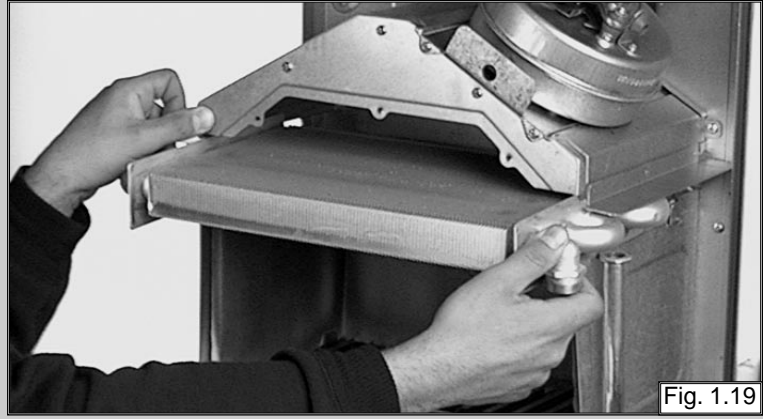
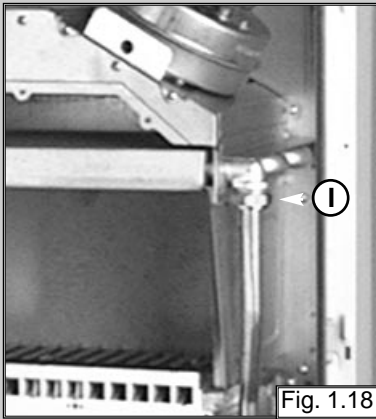

Removing the air pressure switch

1. Disconnect the electrical connections "K" and silicone pipes "L" from their connection points (see fig. 1.20);
2. Remove screws "J" on the top of the sealed chamber (see fig. 1.21); Use a No. 2 star tip screwdriver to remove the switch from the plate.

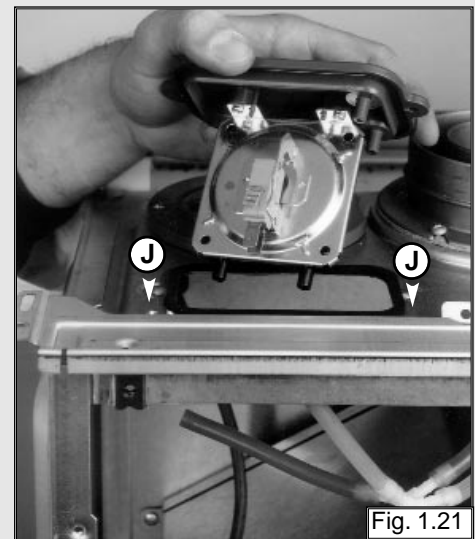
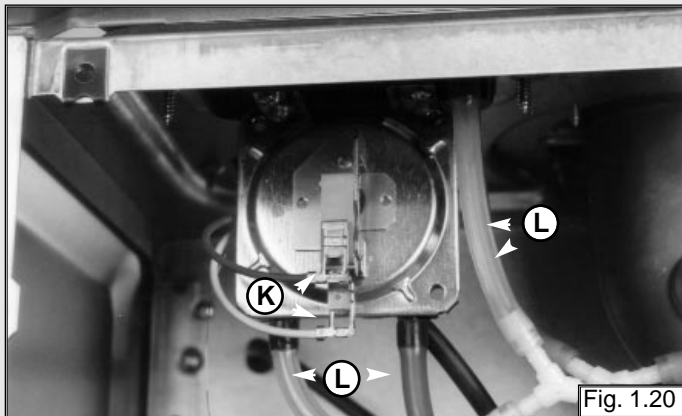

Removing the venturi device

1. Disconnect the silicone pipes "M" and remove the screw "N" (see fig. 1.22);
2. Extract the venturi (see fig. 1.23).

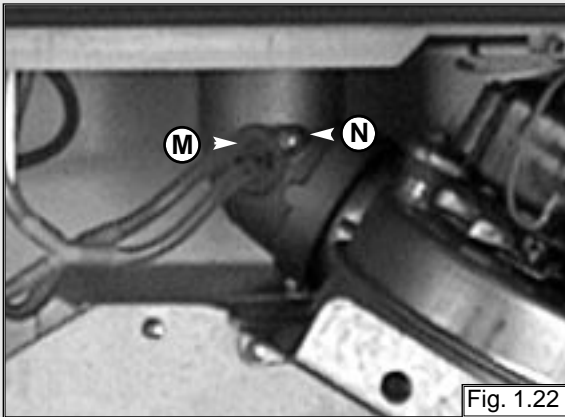

Fig. 1.22

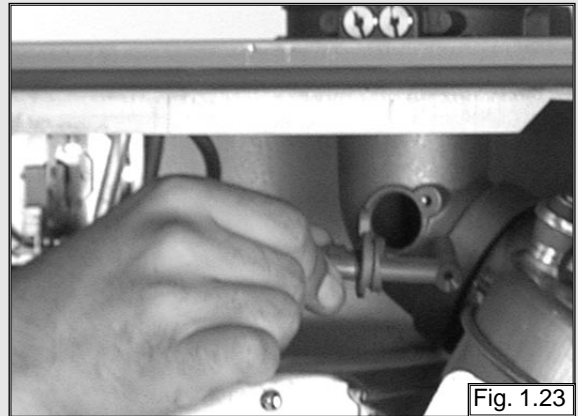

Fig. 1.23

Removing the fan

1. Disconnect electrical connections and remove screws "O" using a No. 2 star tipped screwdriver (see fig. 1.24);
2. Pull fan to the right, forward and remove (see fig. 1.25);
3. Remove fan from mounting plate;
4. Remove screws "P" (see fig. 1.26).

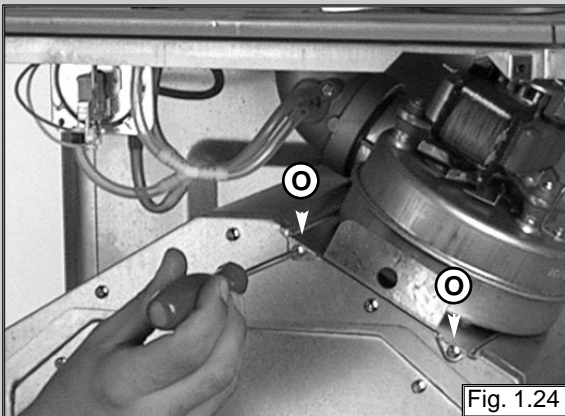

Fig. 1.24

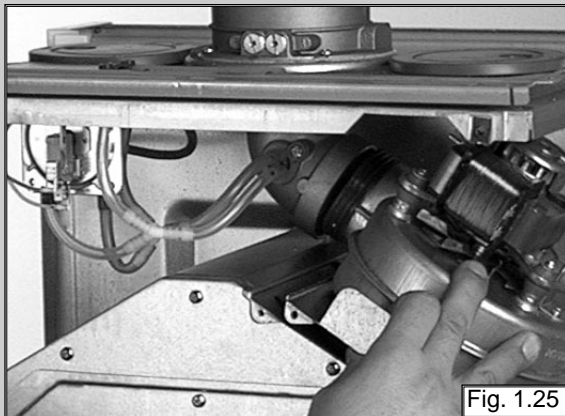

Fig. 1.25

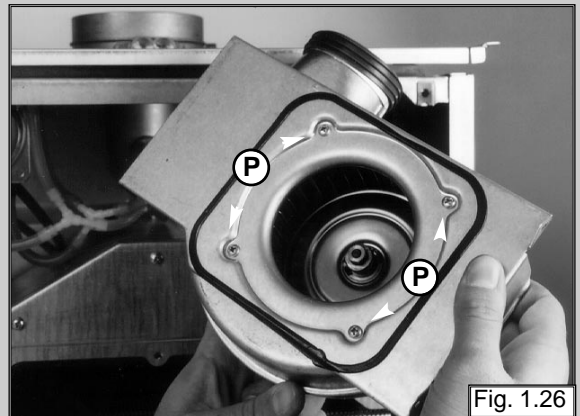
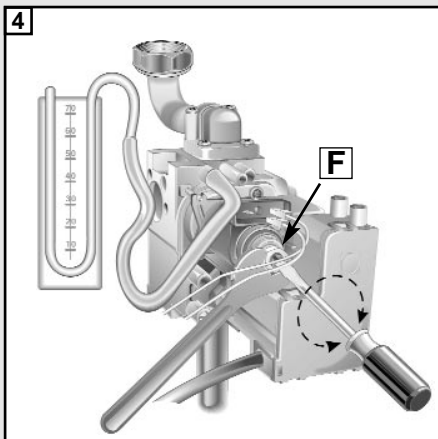
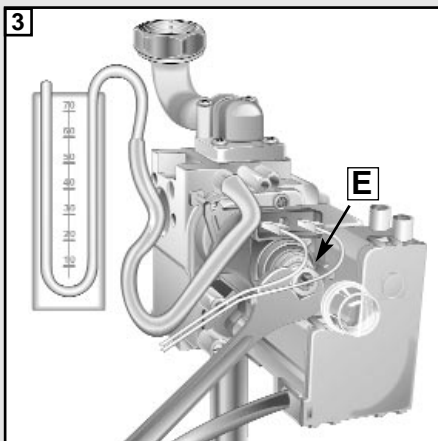
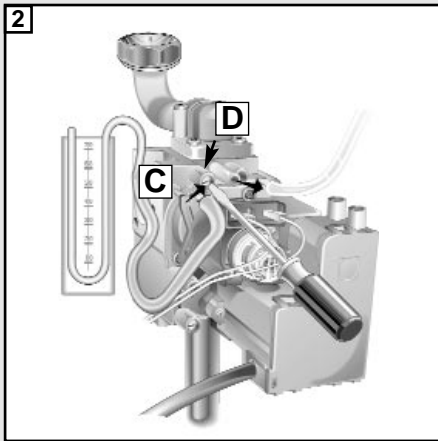
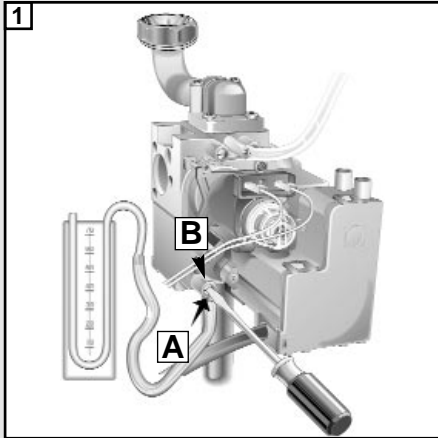

Fig. 1.26

1.4 Servicing and Removal of the Gas Valve

SIT SIGMA



SIT TANDEM

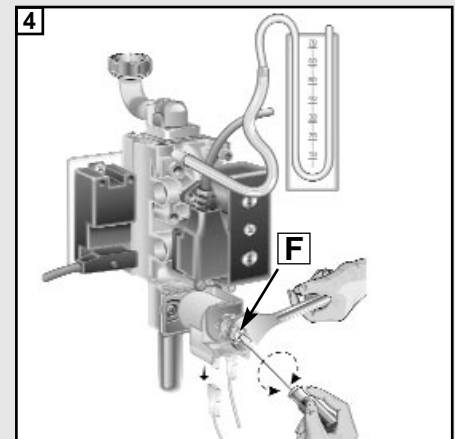
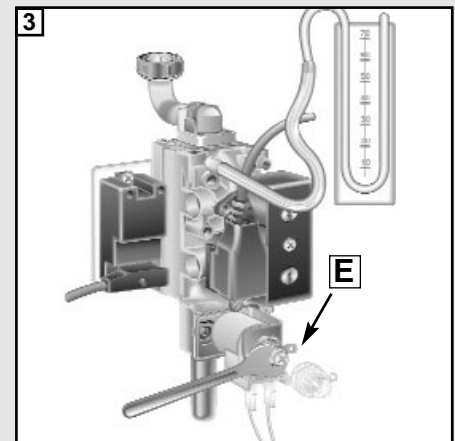
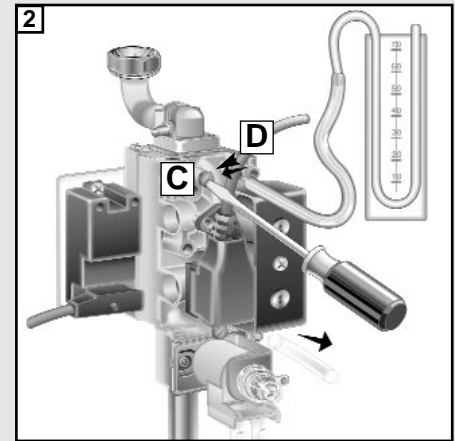
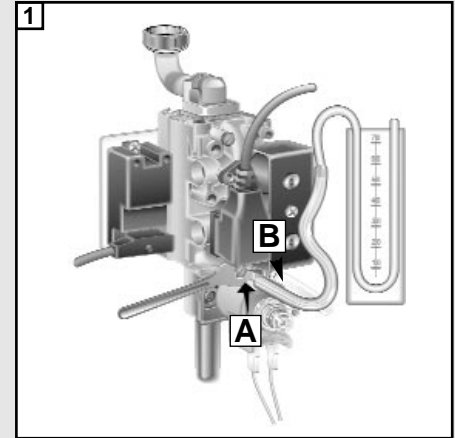

Setting gas pressures

Setting the minimum and the maximum power of the boiler

1. Check that the supply pressure to the gas valve is a minimum of 20 mbar for natural gas.
2. To do this, remove the screw "A".
Fit the pipe of the pressure gauge to the pressure connection of the gas valve "B".
When you have completed this operation, replace the screw "A" securely into its housing to seal off the gas.
3. To check the pressure supplied by the gas valve to the burner, remove the screw "C". Fit the pipe of the pressure gauge to the pressure outlet of the gas valve "D".
Disconnect the compensation pipe either from the gas valve or from the sealed chamber.
4. Set the On/Off button to position < ① > and the "summer/winter" switch to the winter position.
To set the maximum power, turn on the hot water tap and allow the hot water tap to run at a rate of about 8 litres/minute so that the main burner lights.
Adjust nut "E" on the modureg to set the gas pressure (displayed on the pressure gauge) corresponding to the maximum power (see table "A" page 11).
5. To set the minimum power, disconnect a supply terminal from the modureg and adjust screw "F".
Turn the screw clockwise to increase the pressure and counter-clockwise to decrease the pressure (displayed on the pressure gauge) corresponding to the minimum power (see table "A" page 11).
6. When you have completed the above operations, turn off the hot water tap, re-connect the supply terminal to the modureg on the gas valve and replace the cap on the screw of the modureg.

Setting the maximum heating circuit power

7. To set the maximum heating circuit power, place the On/Off button to position < ① > and the "summer/winter" switch to winter position.
Turn the knob of the heating thermostat clockwise to maximum;
8. Remove the left hand inspection panel of the P.C.B. and fit a small cross-head screwdriver in to the right hand potentiometer. Turn clockwise to increase the pressure or counter-clockwise to reduce the pressure.
Adjust the setting to the required heating pressure value (displayed on the pressure gauge), as indicated in the diagrams shown in page 11.
9. Turn off the boiler by placing the main switch to the "Off" position.

Setting pressure for soft ignition.

Disconnect the detection electrode connection from the P.C.B. (see fig. 1.13).

Start the boiler and during the ignition sequence adjust the centre potentiometer until the gas pressure reads the required gas pressure as per the table below.

Once the gas pressure is set turn off the boiler and reconnect the connection to the P.C.B.

NB.: It may be necessary to reset the flame failure reset a number of times during this operation.

	NATURAL GAS (G20)	BUTANE GAS (G30)	PROPANE GAS (G31)
Recommended pressure for slow ignition	5 mbar - 1.95 in w.g.	18 mbar - 7.0 in w.g.	19 mbar - 7.4 in w.g.

Regulating the heating power for natural gas (G20)

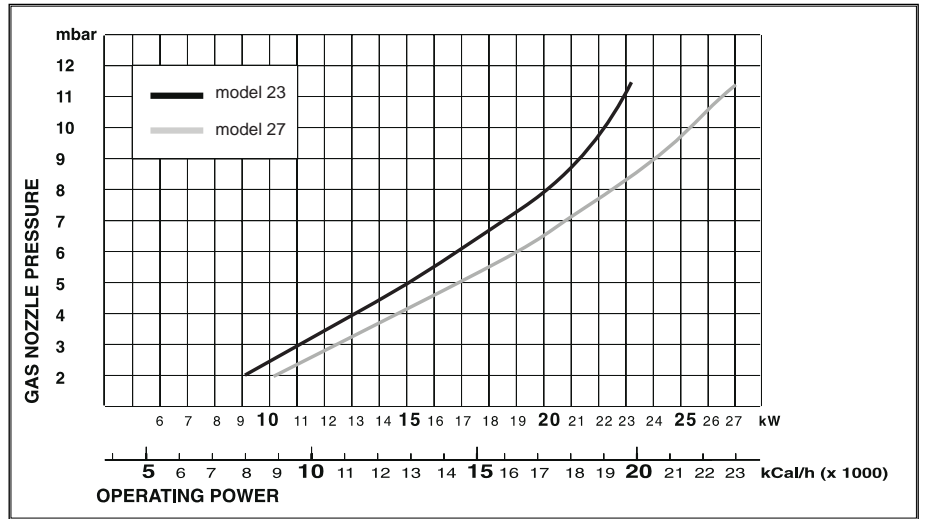

Regulating the heating power for butane gas (G30)

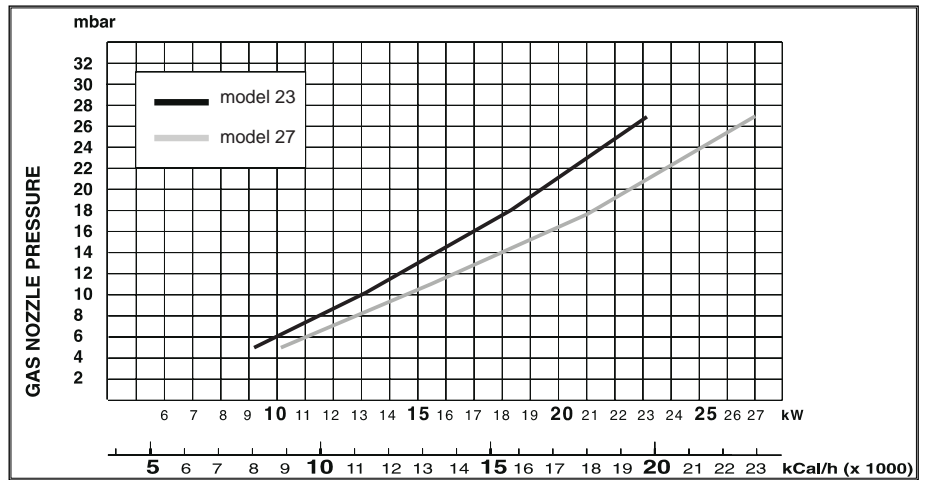

Regulating the heating power for propane gas (G31)

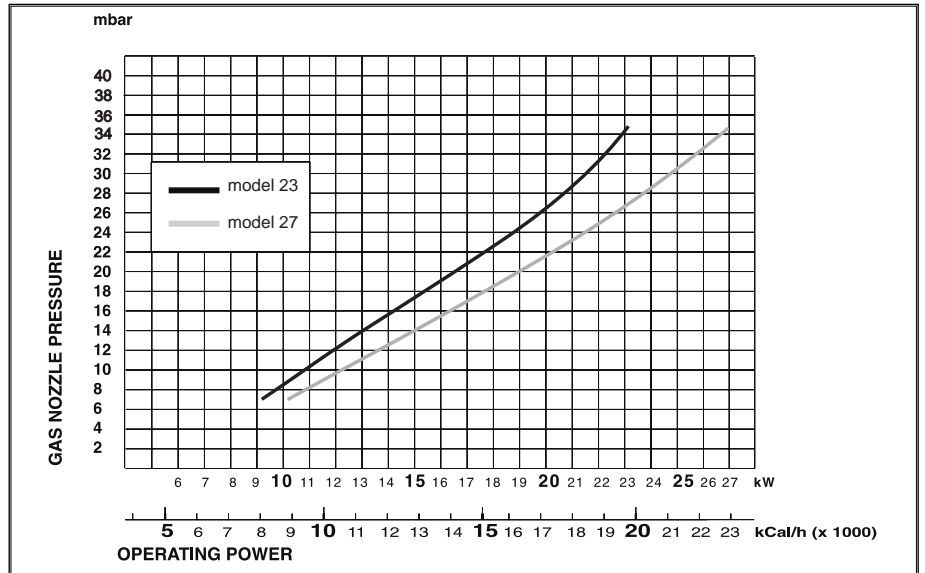
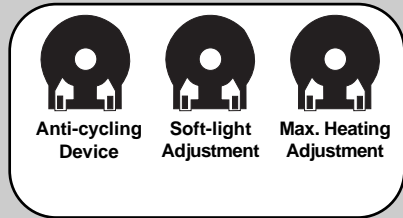
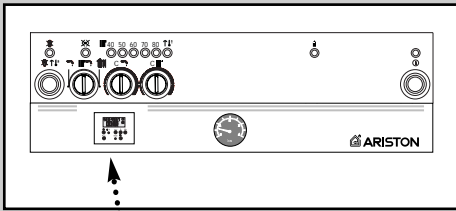

TABLE "A"

GAS REQUIREMENTS		NATURAL GAS (G20)		BUTANE GAS (G30)		PROPANE GAS (G31)	
Gas rate	max	3.0 m ³ /h	106.0 ft ³ /h	0.88 m ³ /h	31.1 ft ³ /h	1.15 m ³ /h	40.6 ft ³ /h
Gas rate	min	1.2 m ³ /h	42.3 ft ³ /h	0.35 m ³ /h	12.3 ft ³ /h	0.46 m ³ /h	16.2 ft ³ /h
Inlet pressure		20 mbar	7.8 in w.g.	28 mbar	10.9 in w.g.	37 mbar	14.4 in w.g.
Burner pressure	max	12.3 mbar	4.8 in w.g.	28 mbar	10.9 in w.g.	37 mbar	14.4 in w.g.
Burner pressure	min	2.0 mbar	0.8 in w.g.	5.1 mbar	2.0 in w.g.	7.0 mbar	2.7 in w.g.
Burner injectors		13 x 1.25		13 x 0.72		13 x 0.72	



10. Remove the pipe from the pressure gauge and connect screw "C" to the pressure outlet in order to seal off the gas.
11. Carefully check the pressure outlets for gas leaks (valve inlet and outlet).

IMPORTANT!

Whenever you disassemble and reassemble the gas connections, always check for leaks using a soap and water solution.

Setting the anti-cycling device

This appliance is equipped with a potentiometer which delays the ignition of the heating control and is situated on the P.C.B. (see the electrical diagrams). By adjusting the potentiometer, it is possible to change the time interval between the burner shutting down and its next ignition.

It is preset at 1 minute and can be adjusted from 0 to 2 minutes.

Use this control in particular situations where continuous shutting down and ignition of the main burner occurs.

Removing the spark generator (SIT Sigma gas valve)

1. Disconnect ignition leads "Q" by pulling upwards (see fig. 1.27);
2. Remove the screws "R" (see fig. 1.28) with a Pozidrive No. 2 star tip screwdriver;
3. Remove the spark generator.

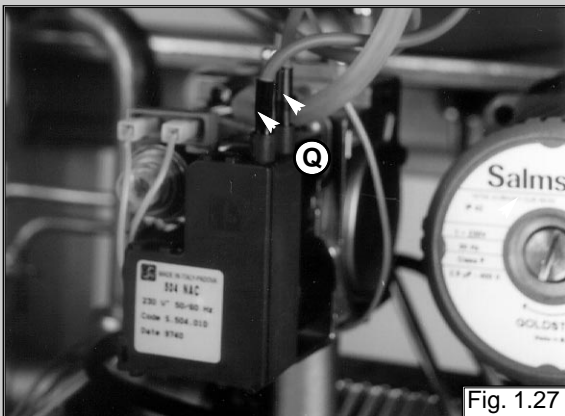

Fig. 1.27

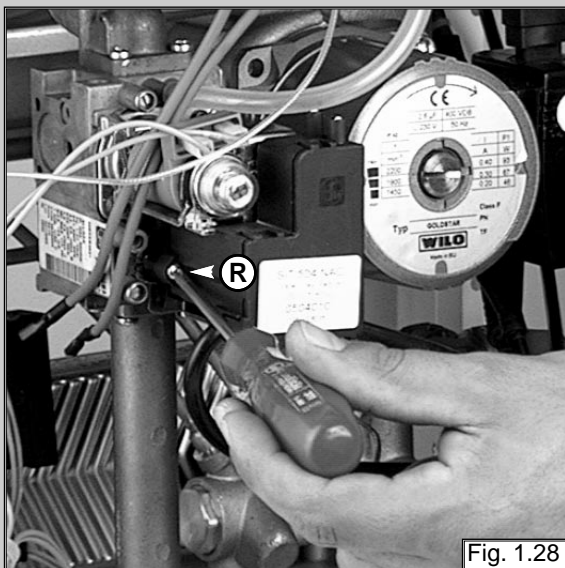

Fig. 1.28

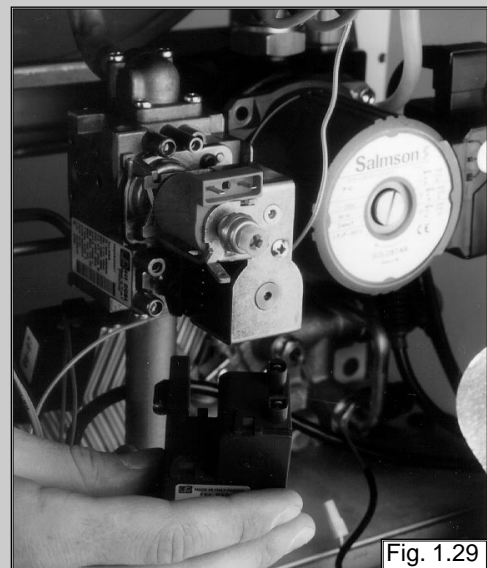
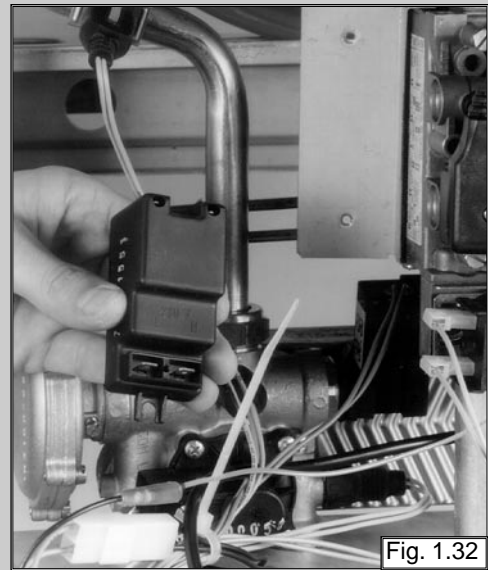
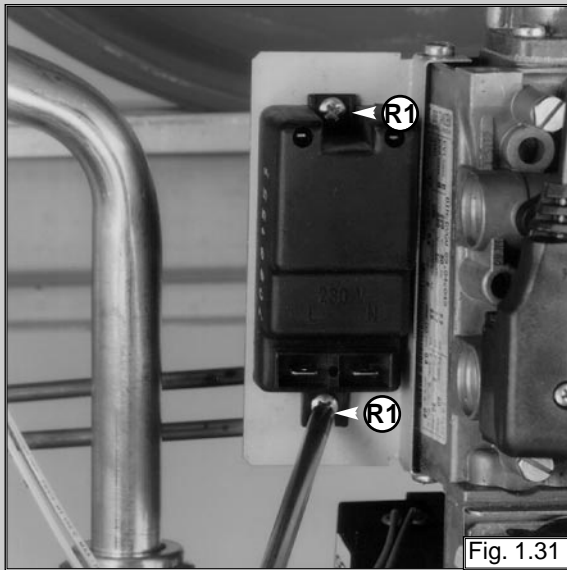
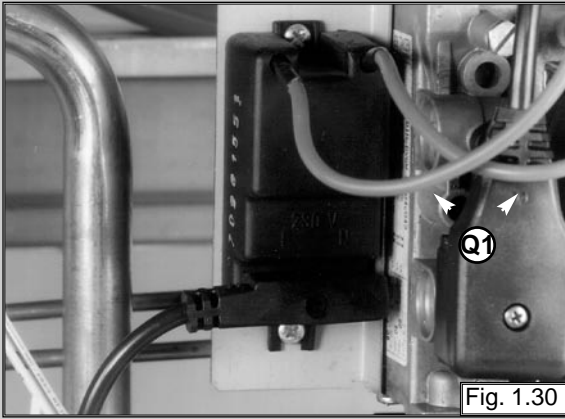

Fig. 1.29

Removing the spark generator (SIT Tandem gas valve)

1. Disconnect ignition leads "Q1" by pulling upwards (see fig. 1.30);
2. Remove the screws "R1" (see fig. 1.31) with a Pozidrive No. 2 star tip screwdriver;
3. Remove the spark generator.



Removing the gas valve

1. Disconnect all the cables from the solenoid and modureg;
2. Remove the spark generator;
3. Release the top nut "S" using a 30 mm open ended spanner (see fig. 1.31);
4. Remove the screws "T" from the bottom of the gas valve pipe (see fig. 1.32).

Attention!! The gas valve is connected with the two pipes (as shown) with an O-ring connection.

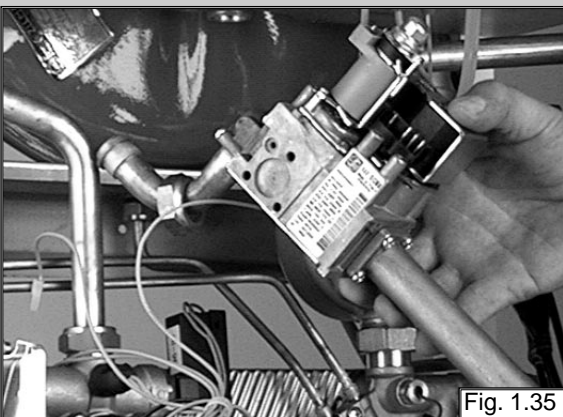
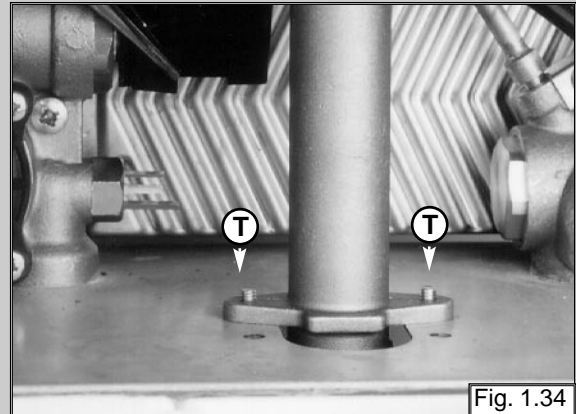
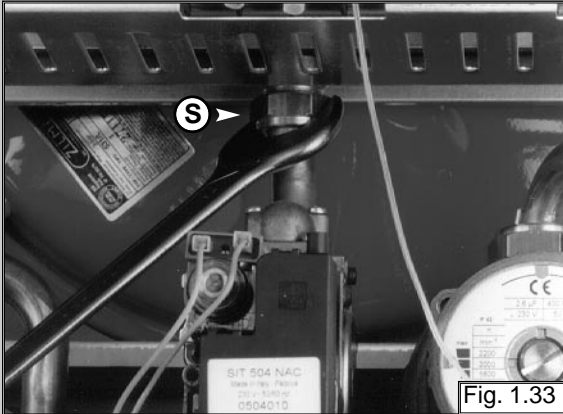

1.5 Access to the Hydraulic Circuits

Important! Before any component is removed, the boiler must be drained of all water.

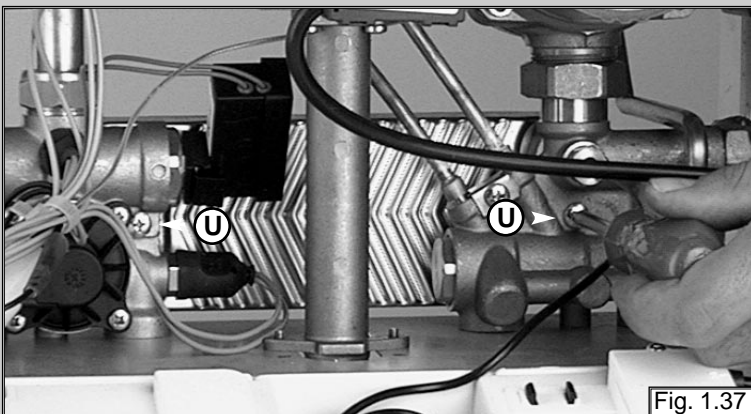

Removing the D.H.W. (secondary) exchanger

1. Remove the screw "U" (see fig. 1.37);
2. Push the exchanger towards the rear of the boiler, lift upwards and remove out of the front of the boiler;
3. Before replacing the exchanger ensure that the O-rings are in good condition and replace if necessary.

Removing the safety valve

1. Loosen nut "V" (see fig. 1.38);
2. Remove the valve.



Removing the automatic air vent

1. Unscrew valve "W" (see fig. 1.39).



Removing the main circuit flow switch

1. Remove the cable of the main circuit flow switch "Y";
2. Remove the screws "Y1" (see fig. 1.40);
3. Remove the main circuit flow switch.

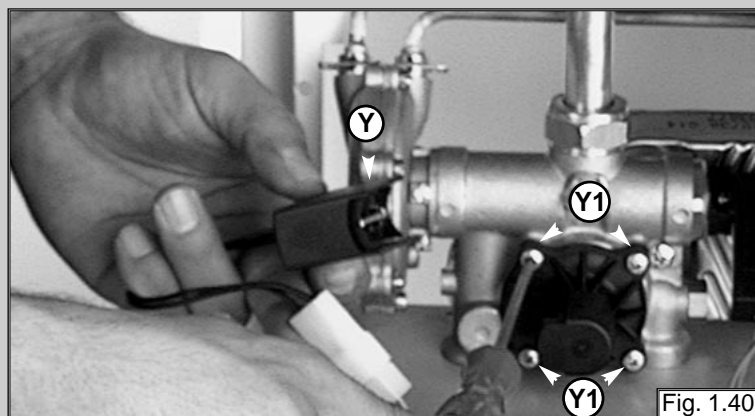

Removing the pump

1. Unscrew "Z" and remove the electrical connection (see fig. 1.41);
2. Release the nuts "A1" and remove the pump (see fig. 1.42).

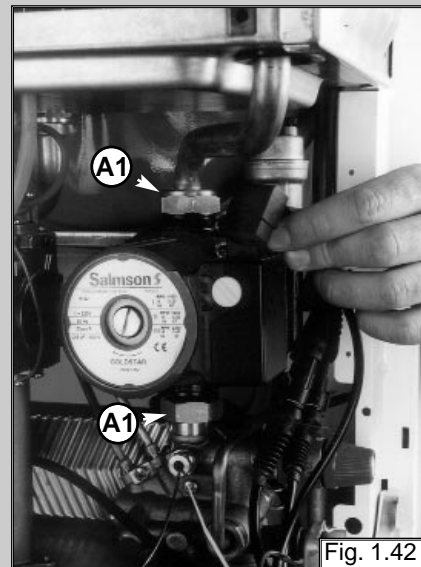
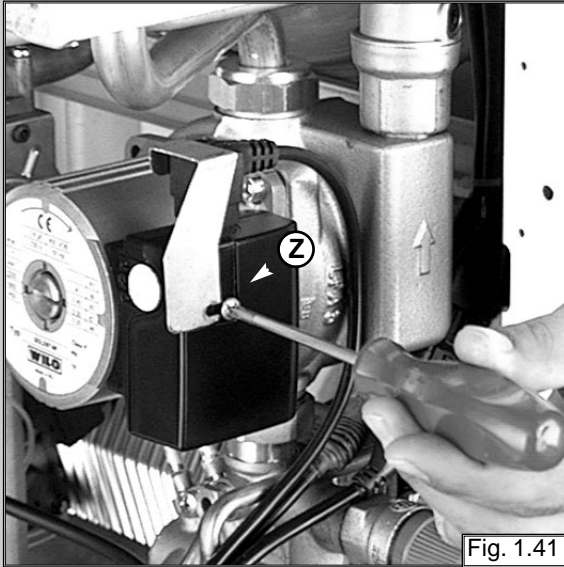

Removing the pressure gauge

1. Remove the inspection panel (see fig. 1.6 - 1.7);
2. Release coupling "A2" using a 14 mm open ended spanner (see fig. 1.43);
3. Push the pressure gauge through the control panel from the rear (see fig. 1.44).

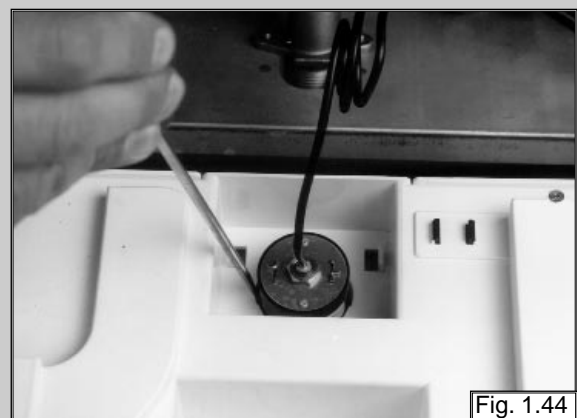
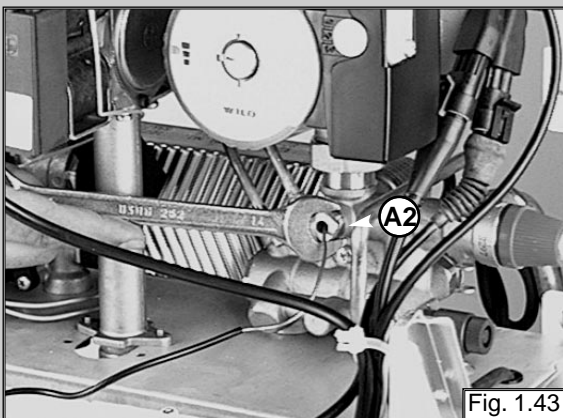

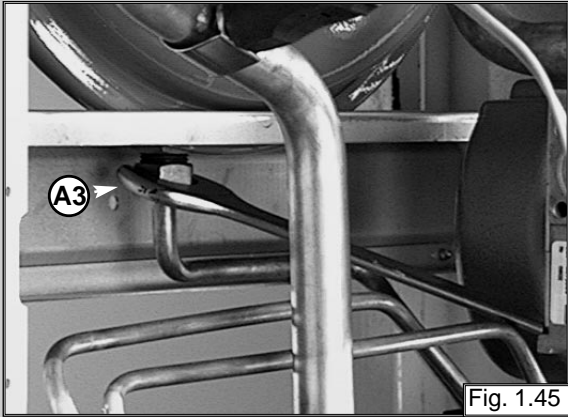

Fig. 1.45

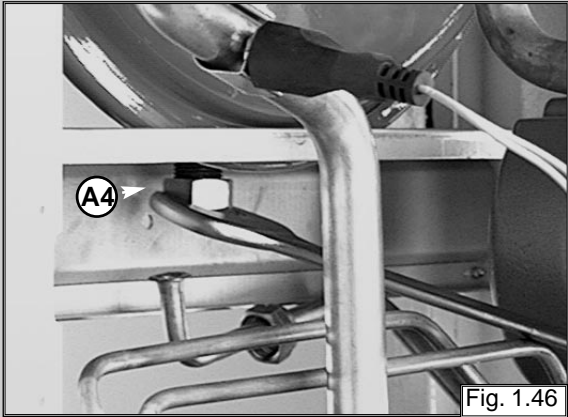

Fig. 1.46

Removing the expansion vessel

1. Remove nut "A3" away from the expansion vessel (see fig. 1.45);
2. Remove nut "A4" (see fig. 1.46);
3. Remove expansion vessel (see fig. 1.47).

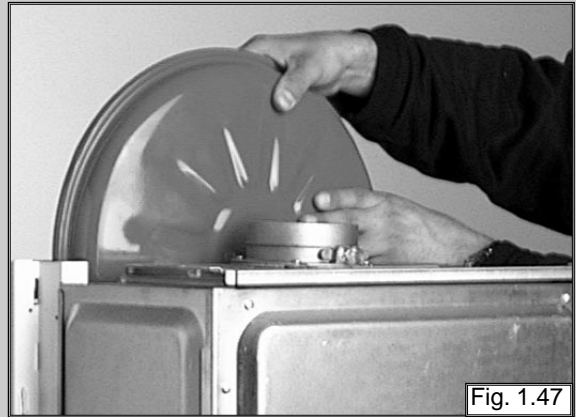

Fig. 1.47

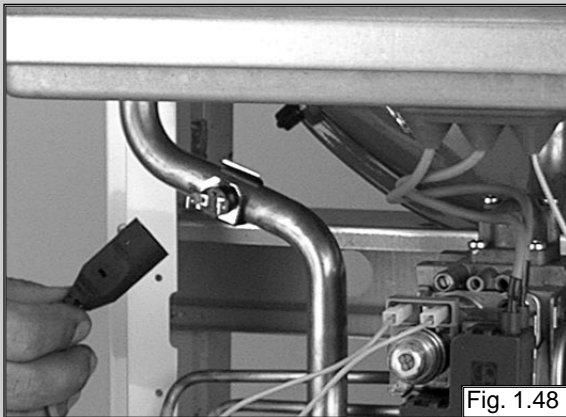

Fig. 1.48

Removing the overheat thermostat

1. Remove the electrical connection from the overheat thermostat (see fig. 1.48);
2. Then remove the thermostat from the pipe by releasing its securing clip.

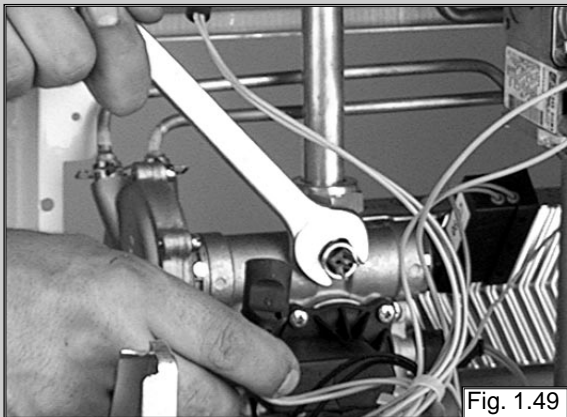

Fig. 1.49

Removing the heating temperature sensor (N.T.C.)

1. Remove the electrical connector by pulling off the thermostat connections and unscrewing the sensor probe with a 14 mm open ended spanner (see fig. 1.49).

1.6 Access to the Control System

Checking fuse

1. Remove the inspection panel (see fig. 1.6 - 1.7);
2. Remove fuse (see fig. 1.50).

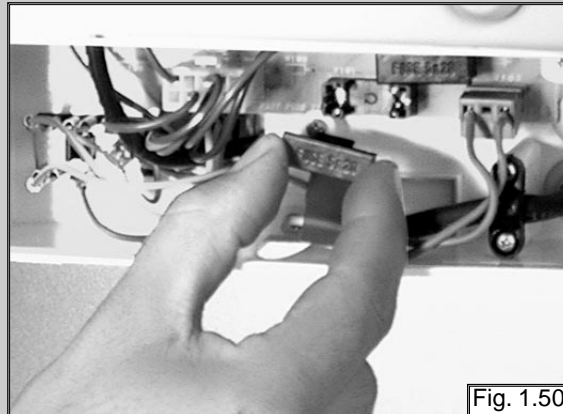

Removing the time clock

1. Remove the inspection panel (see fig. 1.6 - 1.7);
2. Remove electrical connection of the clock "A5" (see fig. 1.51);
3. Unclip the clock from the panel and remove (see fig. 1.52).

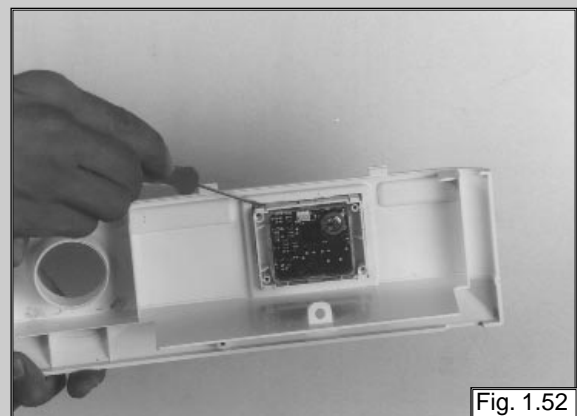
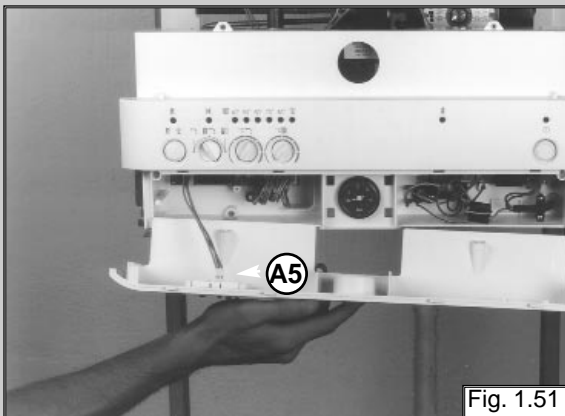

N.B.

It is possible to by-pass the time clock in the event of failure by simply unplugging the electrical connection from the P.C.B. (see fig. 1.48). This will revert control of the central heating to the room stat connection on the reverse of the control panel.

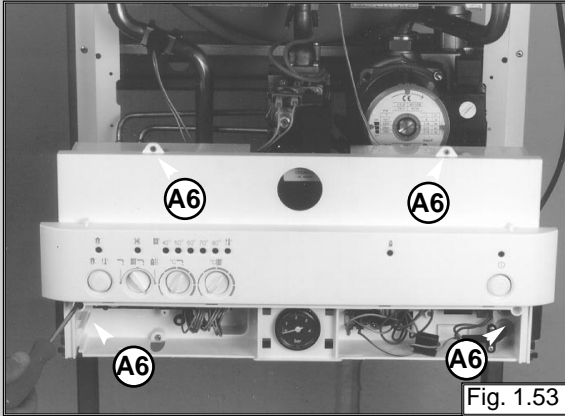

Fig. 1.53

Removing the P.C.B.s

1. Isolate electricity;
2. Remove the front cover of the boiler;
3. Remove the inspection panel (see fig. 1.6-1.7);
5. Remove the mounting screws "A6" (see fig. 1.53);
6. Disconnect the connection cable "A7" (see fig. 1.54);
7. To remove the 24V P.C.B.: remove the electrical plug connectors and screws "A8" (see fig. 1.55);
8. To remove the 240V P.C.B.: remove the electrical plug connectors and screws "A9" (see fig. 1.56);
9. Replace either P.C.B. in reverse order.

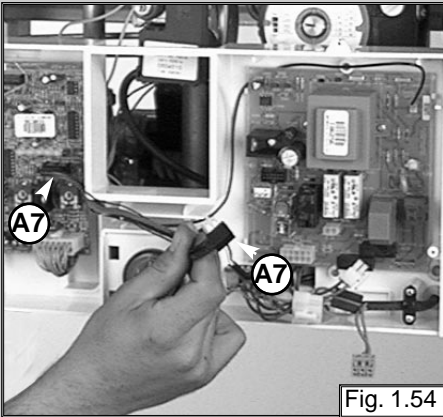

Fig. 1.54

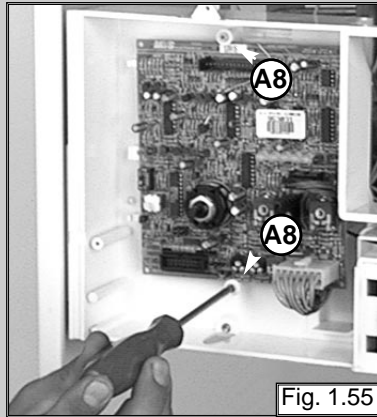

Fig. 1.55

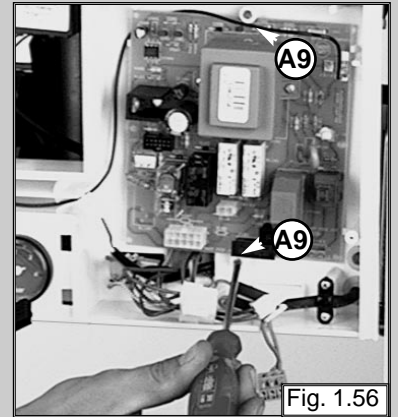
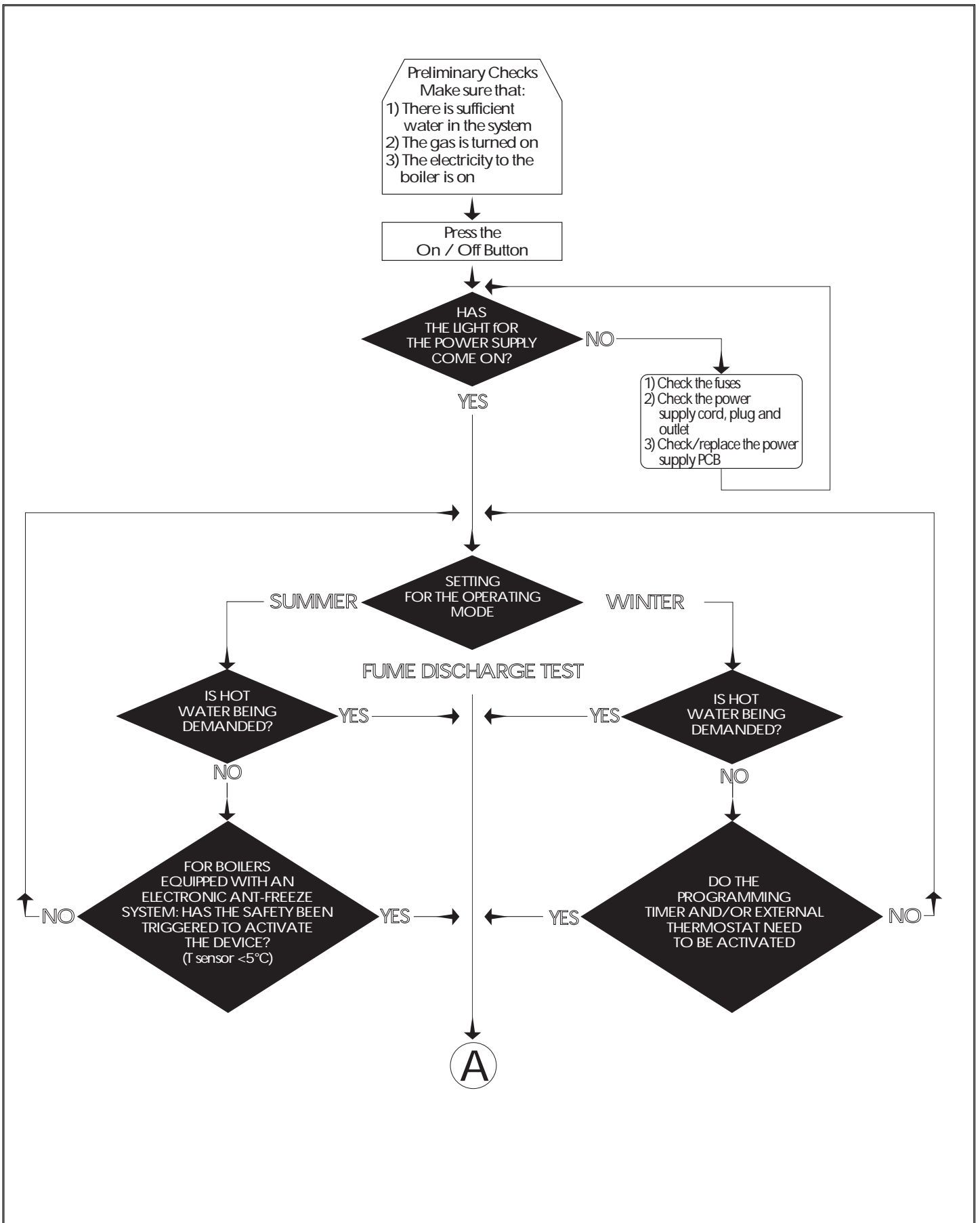

Fig. 1.56

2. FAULT FINDING

2.1 Fault Finding Guide (Flow-chart)

It is possible to detect and correct any defect by using the standard fault finding diagrams described in this chapter.



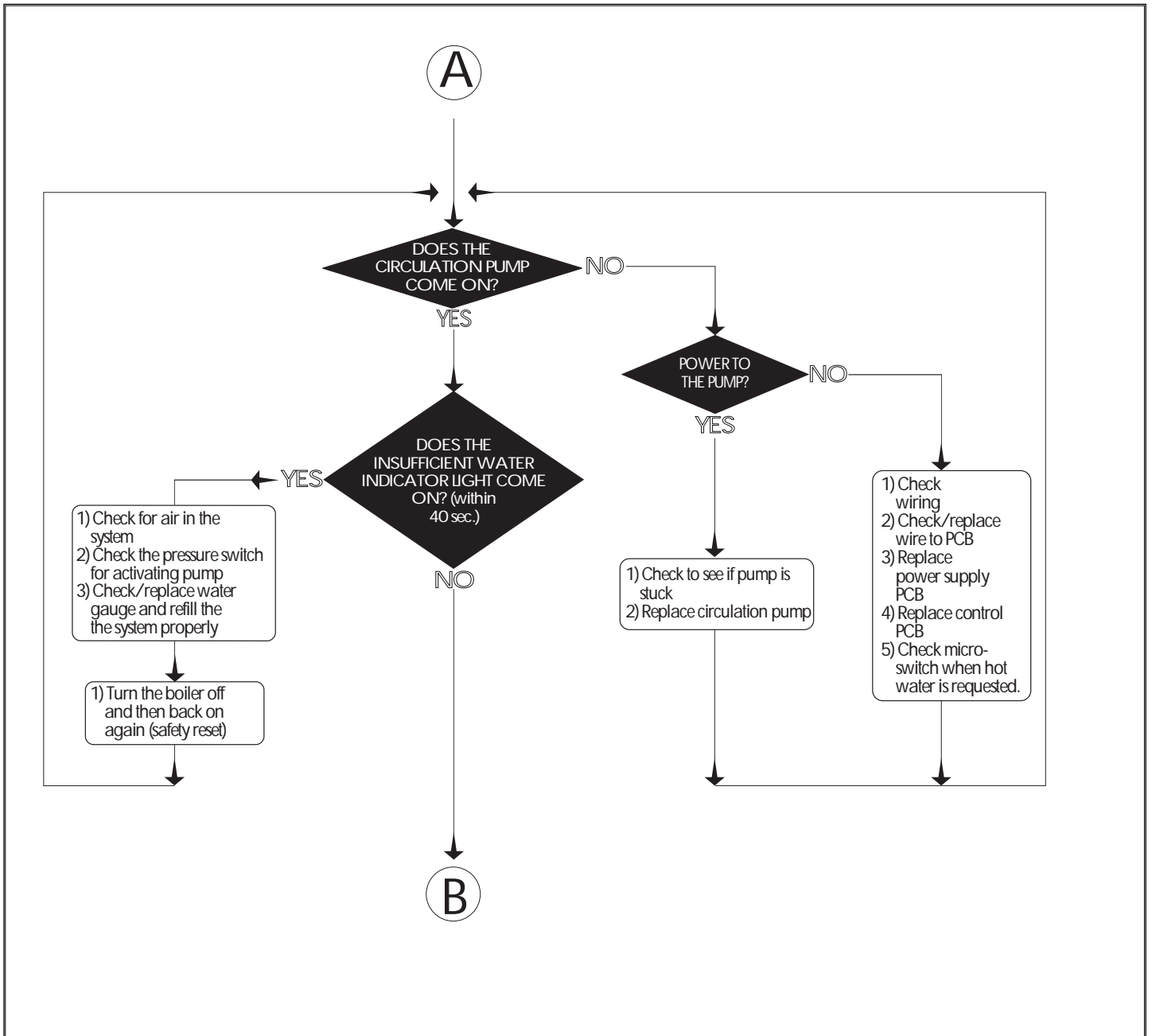

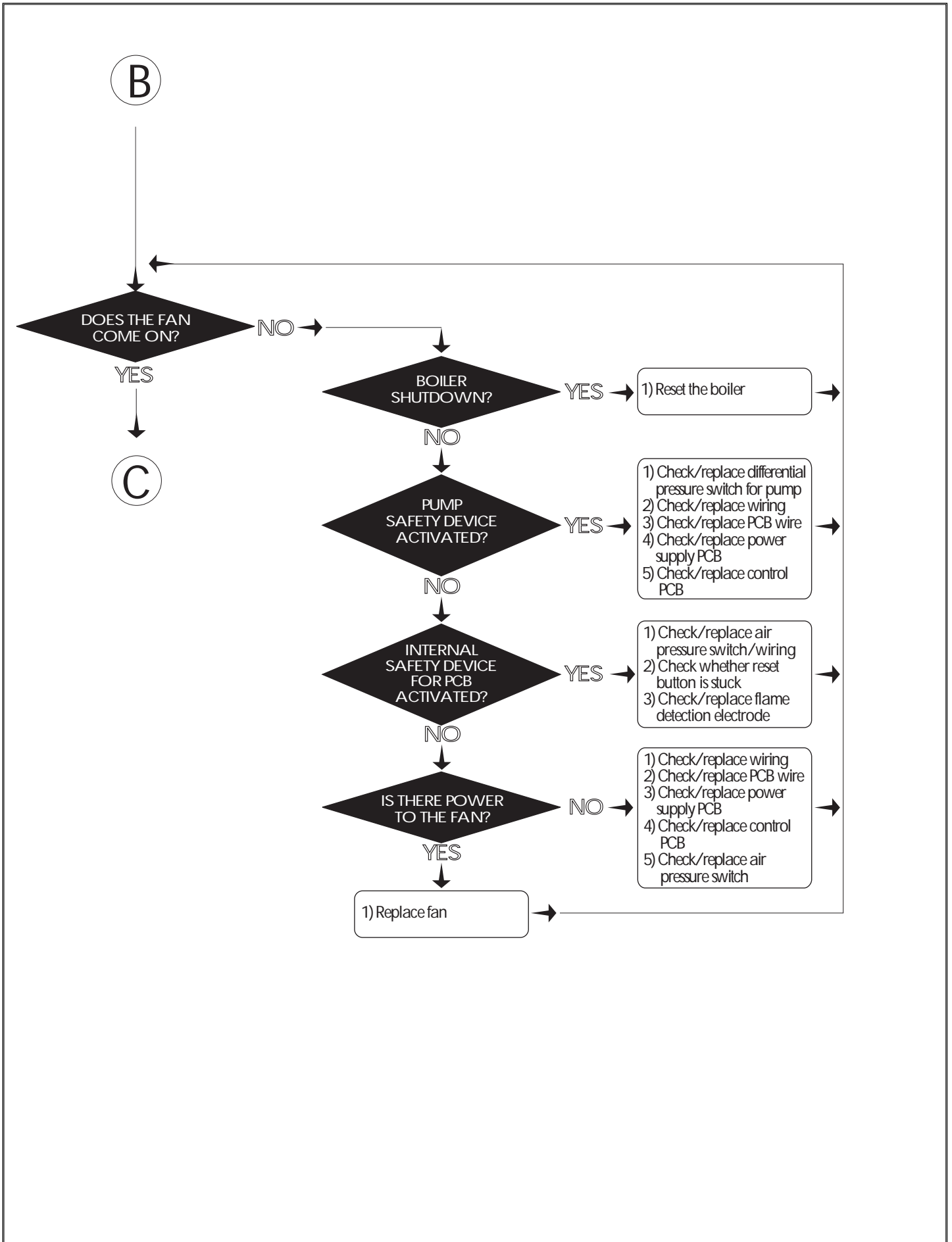

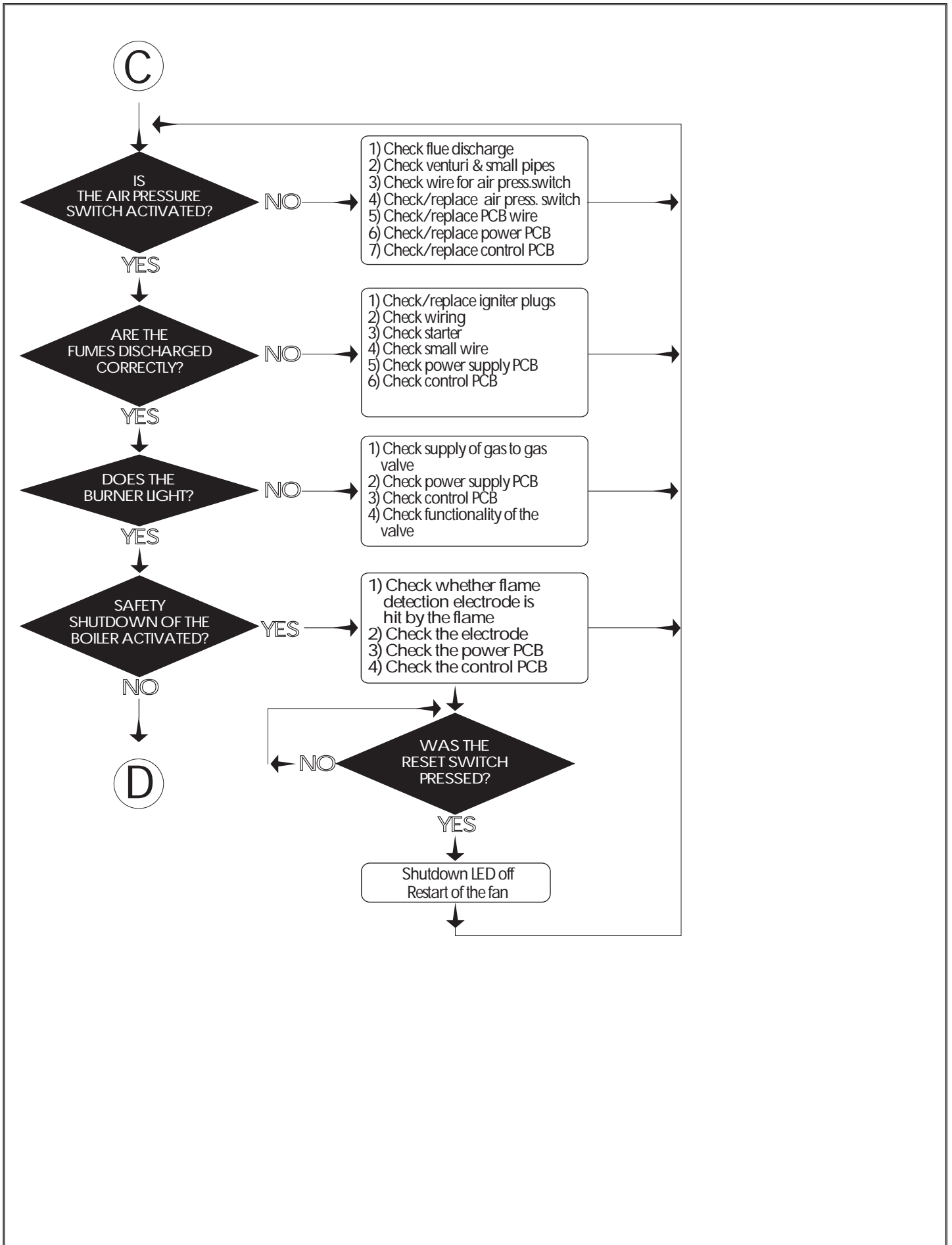

D



	<i>LIST OF MALFUNCTIONS</i>	<i>POSSIBLE CAUSES</i>
1	Delivery of hot water for domestic use: when the tap is turned on, the burner goes out.	<ul style="list-style-type: none"> - Air in the secondary exchanger - Hot water pressure switch is defective - 3-way valve is defective
2	Delivery of hot water for domestic use: the radiators are heated in summer mode.	<ul style="list-style-type: none"> - 3-way valve is defective
3	Delivery of hot water for domestic use: water temperature is not satisfactory.	<ul style="list-style-type: none"> - Check heating sensors - Check gas settings and regulation - Check water flow rate - Check exchanger for domestic hot water
4	Delivery of hot water for domestic use: noisy operation.	<ul style="list-style-type: none"> - Primary exchanger is defective - Low water pressure in heating system - Check gas settings and regulation
5	Drop/increase in pressure in primary circuit.	<ul style="list-style-type: none"> - Check for leaks in heating circuit - Defective water supply inlet valve - Secondary exchanger is defective - Expansion vessel is empty
6	Repeated shutdowns.	<ul style="list-style-type: none"> - Detection electrodes are defective - Check gas settings and regulation - Check electrical circuit for flame detection
7	Safety thermostat is triggered repeatedly.	<ul style="list-style-type: none"> - Faulty (contacts) ntc heating sensors- - Defective (poorly calibrated) safety thermostat - Presence of air in the primary water circuit
8	When the cold water tap is turned off, the boiler comes on.	<ul style="list-style-type: none"> - Drop in pressure in the water mains, resulting in water hammering
9	Temperature of radiators not satisfactory.	<ul style="list-style-type: none"> - Check ntc heating sensor - Check by-pass - Check gas settings and regulation

2.2 Fault Finding Using the Total Check System

Signalling	
	Boiler Off
1	Auto diagnostic state
2	Spark ignition state
3	Boiler functioning normally
4	Lockout
5	Boiler thermostat satisfied
6	Room thermostat/clock no demand or selector in summer setting

Malfunction	
A	Faulty ventilation system
b	Air pressure switch stuck in N.O. position
C	Faulty reset switch
d	Faulty main circuit flow switch
E	Faulty flame detection
F	Faulty overheat thermostat
G	Faulty exhaust fumes sensor
l	Faulty heating sensor (N.T.C.)
m	Faulty D.H.W. sensor (N.T.C.)

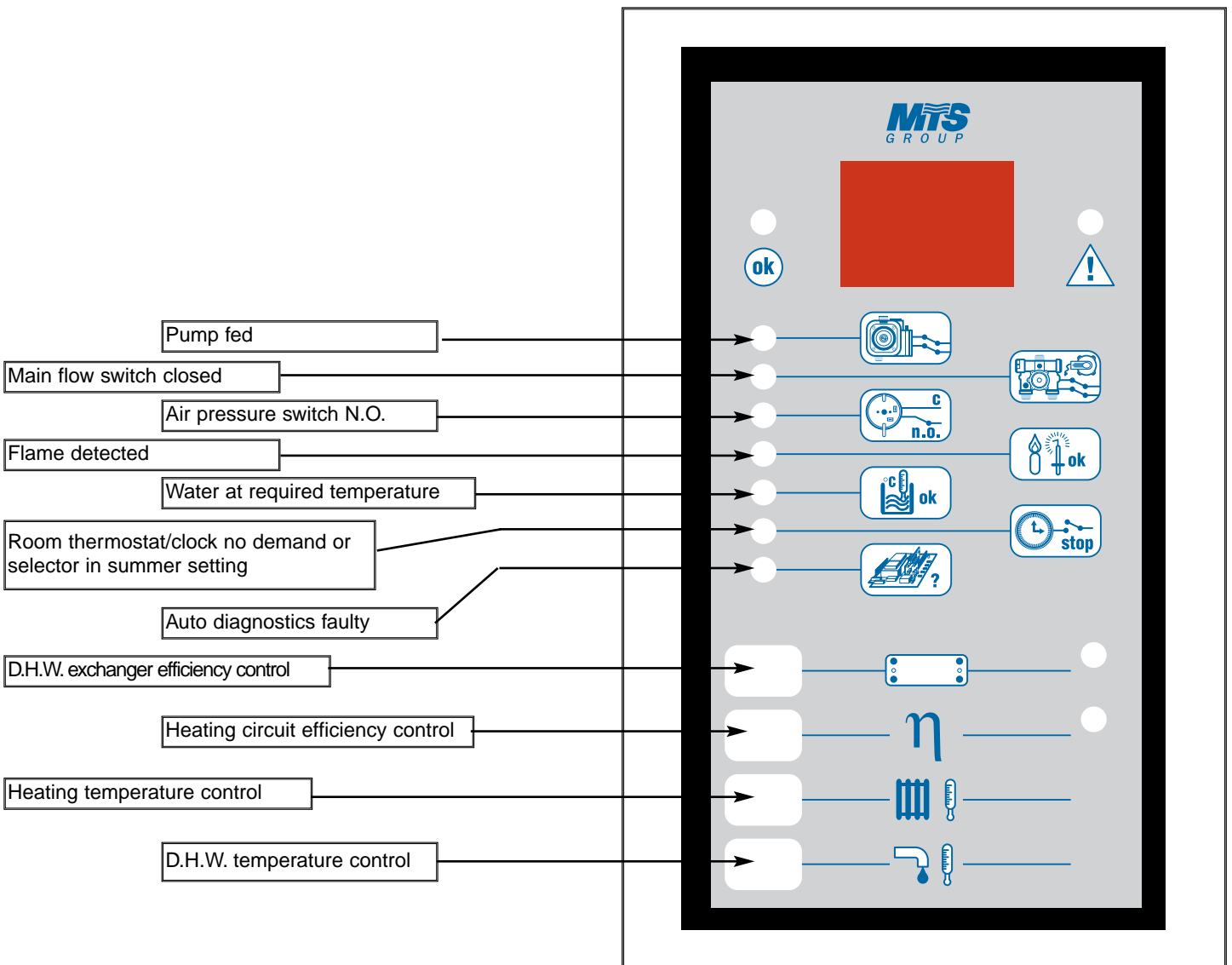

3. ELECTRICAL DIAGRAMS

Legend:

AT = High Voltage P.C.B.
BT = Low Voltage P.C.B.
B = Flame Failure L.E.D.
C = Insufficient Water Pressure L.E.D.
D = Water Temperature Indicator L.E.D.s
E = Overheat Thermostat Warning L.E.D.
F = System Reset Button
G = Selector Knob for Operating Mode
H = Domestic Hot Water Temp. Adjustment
I = Central Heating Temp. Adjustment
J = Wire Connector for Room Thermostat
K = Connector for Total Check System
M = Anti-cycling Device Adjustment for Heating
N = Soft-light Adjustment
O = Max Heating Temperature Adjustment
P = Time Clock Connection
Q = On/Off L.E.D.
R = On/Off Switch
S = Interface Wire for P.C.B.s
T = Relay Motorised Valve
U = Ignitor Relay
V = Gas Valve Relay
W = Fan Relay
X = Circulation Pump Relay
Y = Selector TCS2
Aa = Adaptor (British Gas use only)

A01 = Air Pressure Switch
A02 = Fan
A03 = Gas Valve
A04 = Ignitor
A05 = Motorised Valve
A06 = Circulation Pump
A07 = Flame Detector
A08 = Earth Terminal
A09 = Flame Detection Circuit
A10 = Flame Indicator L.E.D.
A11 = Transformer
A12 = Filter

B01 = Over Heat Thermostat
B02 = Room Thermostat
B03 = Gas Valve Modulator
B05 = Heating Sensor
B06 = Pressure Switch for Heating Circuit
B07 = Microswitch for Diverter Valve
B08 = Time Clock

Colours

Gry = Grey
Rd = Red
Bl = Blue
Grn/Yll = Yellow/Green
Wh = White
Brn = Brown
Blk = Black
Wh/Rd = White/Red

A/23 MFFI - A/27 MFFI

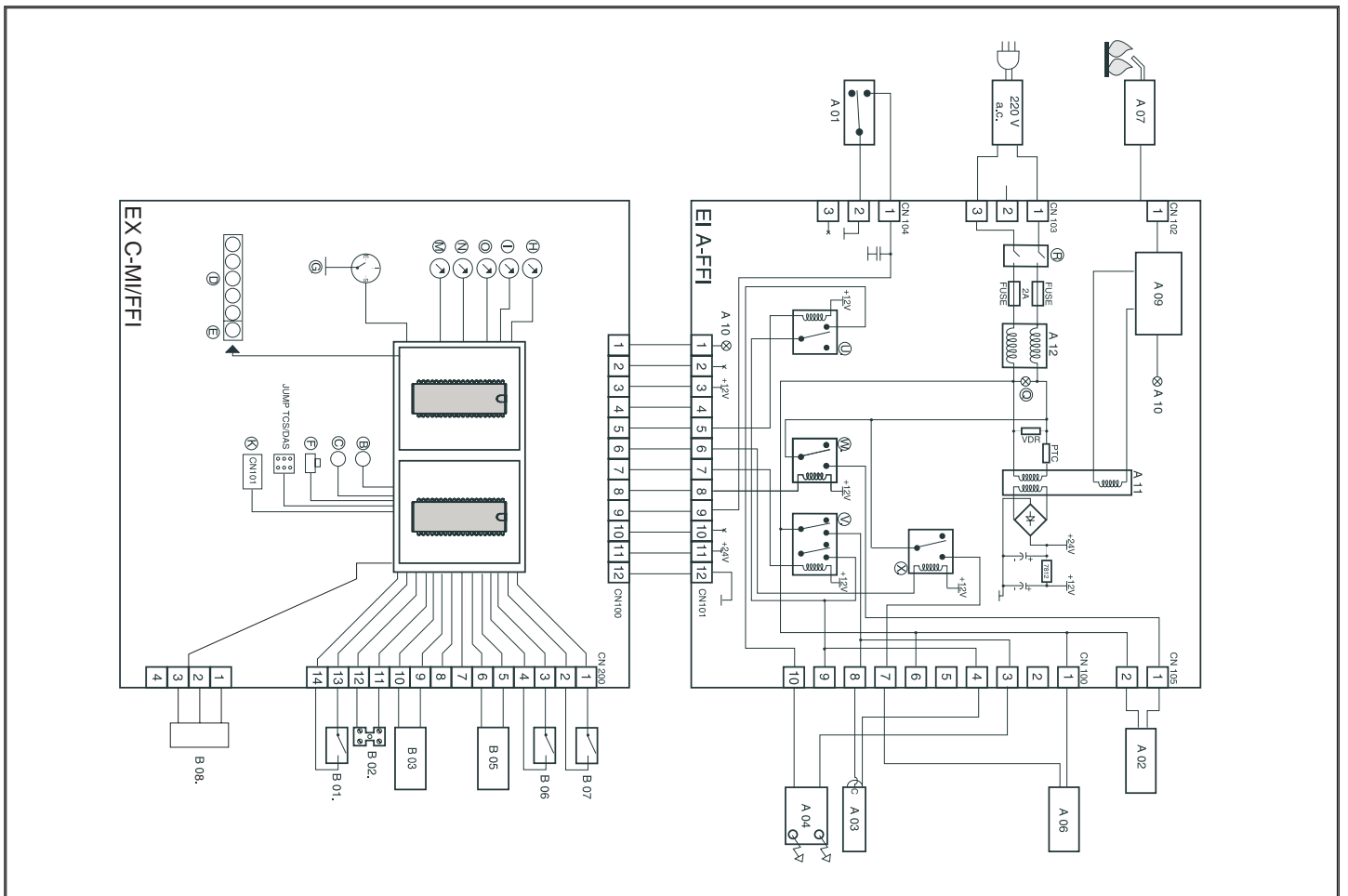
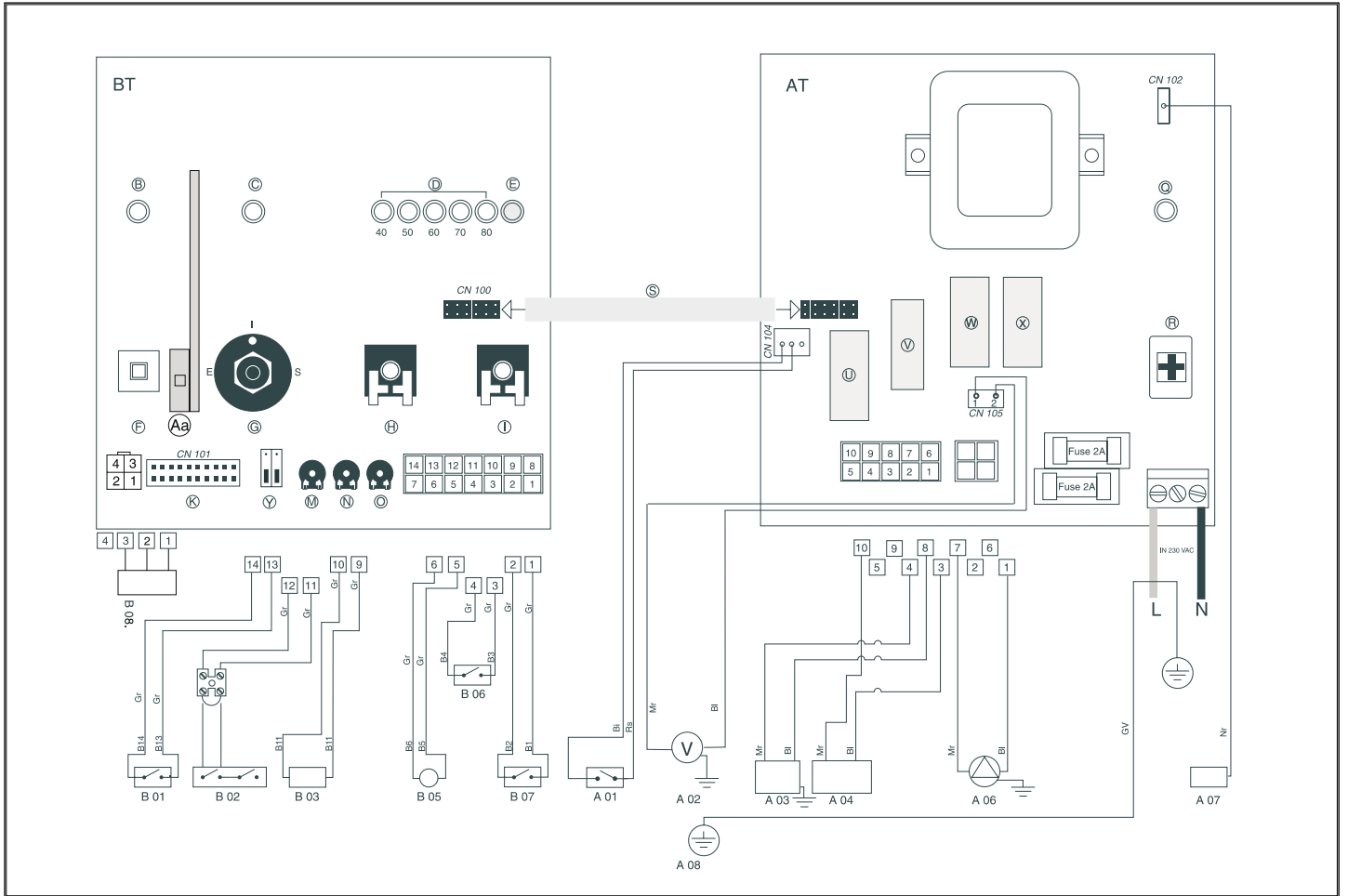

4. SHORT SPARE PARTS LIST

A/23 MFFI - A/27 MFFI (SIT Sigma Gas Valve)

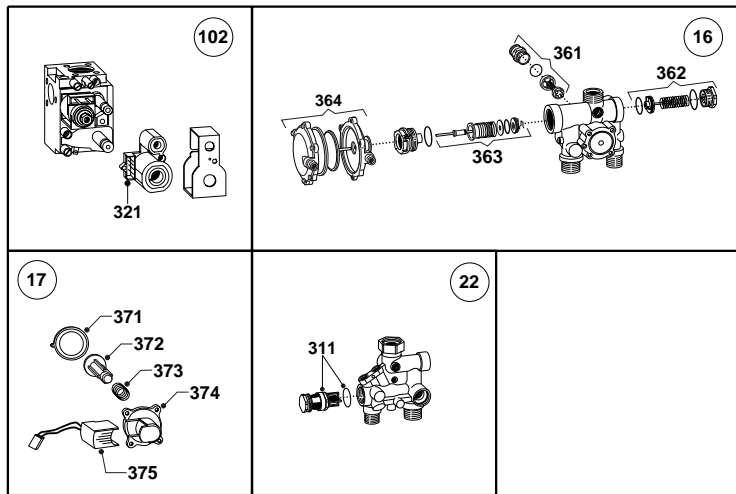
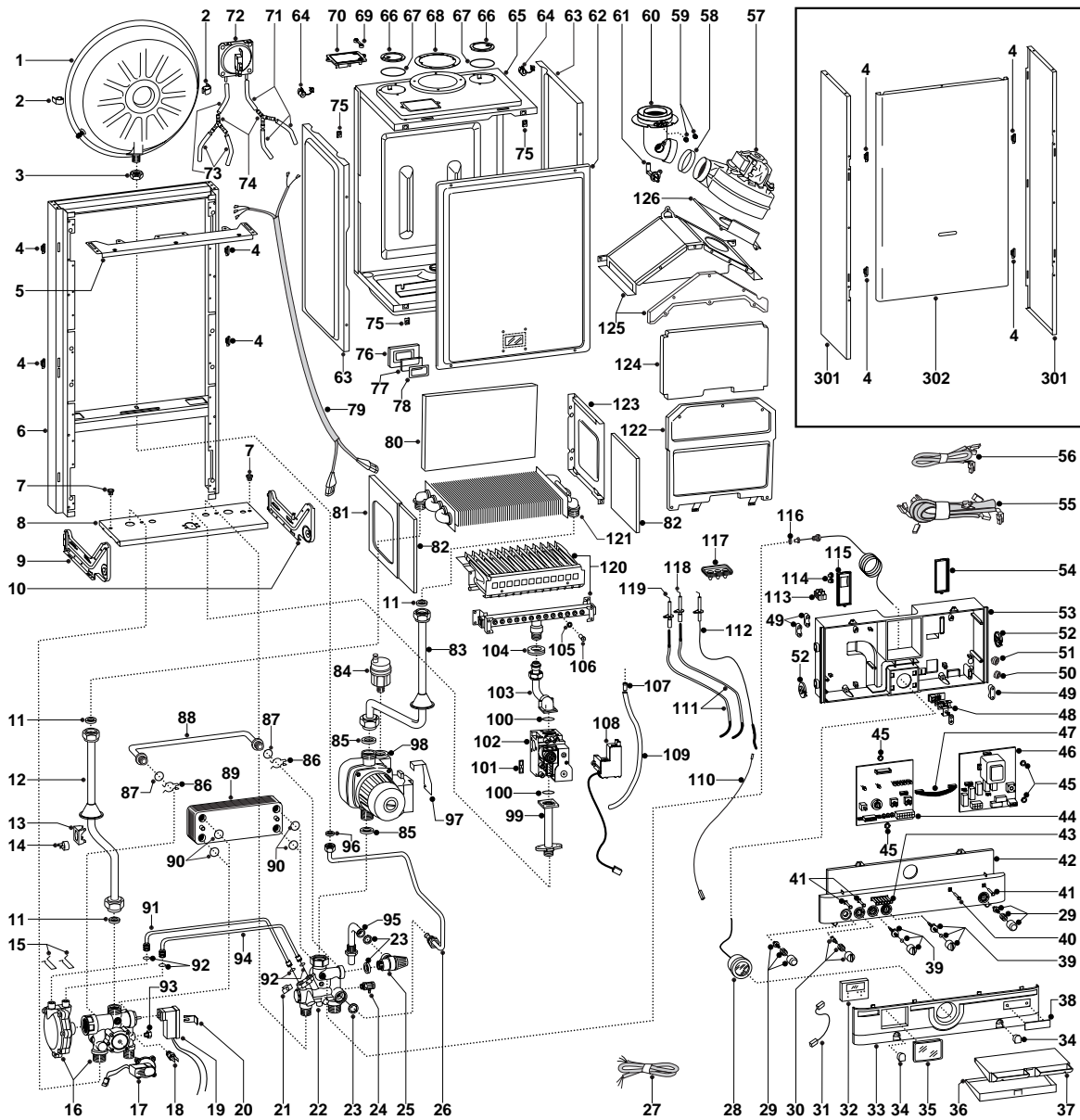

ARISTON
A 23/27 MFFI

A/23 MFFI - A/27 MFFI (SIT Sigma Gas Valve)

Key no.	G.C. part no.	Description	ARISTON Part No.
1		Expansion vessel	573294
11	164 225	Gasket 3/4"	573520
14		Overheat thermostat	997206
17		Main flow Switch	573224
18	164 338	Temp probe (C.H.W.)	569236
19		Microswitch for 3-way/main flow group	573340
23	164 229	Gasket 1/2"	573528
24	378 814	Manual vent cock	573727
25		Safety valve 3 bar 1/2"	573172
28		Pressure gauge	571649
32		Time clock	997208
45		P.C.B. EX C-MI/FFI	953730
46		P.C.B. EI A-MFFI	952981
47		P.C.B. cable	952610
57AB		Fan	572989
57CD		Fan	572990
58		Fan inlet gasket	573343
61		Venturi (exhaust manifold/header)	573314
72AB	E03 818	Air pressure switch	571651
72CD	E02 071	Air pressure switch	571652
75		Fastening spring	570717
84	379 079	Automatic air release valve	564254
85	164 230	Gasket 1"	569387
87		O-ring	571449
89AB		Secondary exchanger (plate-type) exchanger 23kW	571646
89CD		Secondary exchanger (plate-type) exchanger 27kW	573295
90		O-ring (secondary exchanger)	573825
92		20-18 O-ring	571807
96	164 282	Gasket 3/8"	573521
98AB		Pump	997150
98CD		Pump	997151
100		O-ring (13)	571965
101		Gasket	574279
102		Gas valve (SIT Sigma)	574232
108		Spark generator	574233
112	379 981	Detection electrode	573441
116	164 261	Gasket 1/4"	569390
118	379 979	Ignition electrode (R.H.)	569560
119	379 980	Ignition electrode (L.H.)	569561
120A	E02 026	Main burner	572271
120B		Main burner	572277
120C	E02 078	Main burner	572343
120D		Main burner	572372
121AB		Main exchanger	572749
121CD		Main exchanger	572835
301		Front panel runner kit	571993
311		D.H.W. actuator kit	571444
321		SIT Sigma gas valve operator coils	997029
361		Heating by-pass kit	571443
362		D.H.W. pressure switch kit	571442
363		3-way spring kit	571447
364		D.H.W. diaphragm valve	571446
371		Main flow switch diaphragm	571547
372		Main flow switch magnet	571772
373		Main flow switch spring	571771
374		Main flow switch top cap	571770
375		Main flow switch reed system	573138
381	164 311	Burner jet 1.25 full kit (Natural gas)	569281
382		Burner jet 0.72 full kit (LPG)	569282

A/23 MFFI - A/27 MFFI (SIT Tandem Gas Valve)

Key no.	G.C. part no.	Description	ARISTON Part No.
1		Expansion vessel	573294
11	164 225	Gasket 3/4"	573520
14		Overheat thermostat	997206
17		Main flow Switch	573224
18	164 338	Temp probe (C.H.W.)	569236
19		Microswitch for 3-way/main flow group	573340
23	164 229	Gasket 1/2"	573528
24	378 814	Manual vent cock	573727
25		Safety valve 3 bar 1/2"	573172
28		Pressure gauge	571649
31		Time clock	997207
44		P.C.B. EX C-MI/FFI	953730
46		P.C.B. EI A-MFFI	952981
47		P.C.B. cable	952610
57AB		Fan	572989
57CD		Fan	572990
58		Fan inlet gasket	573343
61		Venturi (exhaust manifold/header)	573314
72AB	E03 818	Air pressure switch	571651
72CD	E02 071	Air pressure switch	571652
75		Fastening spring	570717
84	379 079	Automatic air release valve	564254
85	164 230	Gasket 1"	569387
87		O-ring	571449
89AB		Secondary exchanger (plate-type) exchanger 23kW	571646
89CD		Secondary exchanger (plate-type) exchanger 27kW	573295
90		O-ring (secondary exchanger)	573825
92		O-ring (20-18)	571807
96	164 282	Gasket 3/8"	573521
98AB		Pump	997150
98CD		Pump	997151
101	379 976	Gas valve (SIT Tandem)	570732
103		Spark generator	573023
106		O-ring (13)	571965
114	379 981	Detection electrode	573441
118	164 261	Gasket 1/4"	569390
120	379 979	Ignition electrode (R.H.)	569560
121	379 980	Ignition electrode (L.H.)	569561
122A	E02 026	Main burner	572271
122B		Main burner	572277
122C	E02 078	Main burner	572343
122D		Main burner	572372
123AB		Main exchanger	572749
123CD		Main exchanger	572835
311		D.H.W. actuator kit	571444
321	378 978	SIT Tandem gas valve operator coils	570712
322	378 815	SIT Tandem modureg coil	573740
323	164 303	Gas modulator cartridge	573745
361		Heating by-pass kit	571443
362		D.H.W. pressure switch kit	571442
363		3-way spring kit	571447
364		D.H.W. diaphragm valve	571446
371		Main flow switch diaphragm	571547
372		Main flow switch magnet	571772
373		Main flow switch spring	571771
374		Main flow switch top cap	571770
375		Main flow switch reed system	573138
381	164 311	Burner jet 1.25 full kit (Natural gas)	569281
382		Burner jet 0.72 full kit (LPG)	569282

A 23/27 MFFI (SIT Tandem Gas Valve)

Key no.	G.C. part no.	Description	ARISTON Part No.
1		Expansion vessel	573294
11	164 225	Gasket 3/4"	573520
14		Overheat thermostat	997206
17		Main flow Switch	573224
18	164 338	Temp probe (C.H.W.)	569236
19		Microswitch for 3-way/main flow group	573340
23	164 229	Gasket 1/2"	573528
24	378 814	Manual vent cock	573727
25		Safety valve 3 bar 1/2"	573172
28		Pressure gauge	571649
31		Time clock	997207
44		P.C.B. EX C-MI/FFI	953730
46		P.C.B. EI A-MFFI	952981
47		P.C.B. cable	952610
57AB		Fan	572989
57CD		Fan	572990
58		Fan inlet gasket	573343
61		Venturi (exhaust manifold/header)	573314
72AB	E03 818	Air pressure switch	571651
72CD	E02 071	Air pressure switch	571652
75		Fastening spring	570717
84	379 079	Automatic air release valve	564254
85	164 230	Gasket 1"	569387
87		O-ring	571449
89AB		Secondary exchanger (plate-type) exchanger 23kW	571646
89CD		Secondary exchanger (plate-type) exchanger 27kW	573295
90		O-ring (secondary exchanger)	573825
92		O-ring (20-18)	571807
96	164 282	Gasket 3/8"	573521
98AB		Pump	997150
98CD		Pump	997151
101	379 976	Gas valve (SIT Tandem)	570732
103		Spark generator	573023
106		O-ring (13)	571965
114	379 981	Detection electrode	573441
118	164 261	Gasket 1/4"	569390
120	379 979	Ignition electrode (R.H.)	569560
121	379 980	Ignition electrode (L.H.)	569561
122A	E02 026	Main burner	572271
122B		Main burner	572277
122C	E02 078	Main burner	572343
122D		Main burner	572372
123AB		Main exchanger	572749
123CD		Main exchanger	572835
311		D.H.W. actuator kit	571444
321	378 978	SIT Tandem gas valve operator coils	570712
322	378 815	SIT Tandem modureg coil	573740
323	164 303	Gas modulator cartridge	573745
361		Heating by-pass kit	571443
362		D.H.W. pressure switch kit	571442
363		3-way spring kit	571447
364		D.H.W. diaphragm valve	571446
371		Main flow switch diaphragm	571547
372		Main flow switch magnet	571772
373		Main flow switch spring	571771
374		Main flow switch top cap	571770
375		Main flow switch reed system	573138
381	164 311	Burner jet 1.25 full kit (Natural gas)	569281
382		Burner jet 0.72 full kit (LPG)	569282

Manufacturer: **Merloni TermoSanitari SpA - Italy**

Commercial subsidiary: **MTS (GB) LIMITED**

MTS Building

Hughenden Avenue,

High Wycombe

Bucks HP13 5FT

Telephone: (01494) 755600 -

Fax: (01494) 459775

Technical Service Hotline: (01494) 539579